



www.Kutzer.biz

2016 - 2017

Aktualisiert 07.05.2016

Ersatzteilekatalog 2016-2017

Die in diesem Kataloge aufgeführten original Hersteller Teilenummern sollen dir nur helfen die richtigen Teile zu finden. In diesem Katalog gibt es keine Originalteile, alle Produkte stammen von Zulieferern oder sind Nachbauteile.

Aber du wirst hier viele Teile finden die die Schlittenherstellern nicht mehr liefern können...

Der Katalog ist überwiegend auf englisch Übersetzungstools findest du hier:

<http://www.dict.cc/> oder <http://translate.google.de/>

Kutzer Alpine Technologie

Sonnenstr. 1
D-86980 Ingenried

mail@motor-schlitten.de
Tel: +49 (0) 163 755 24 42
Fax: +49 (0)8868 180 211

Das ist der Katalog eines skandinavischen Großhändlers, von dem wir der Deutschland Distributor sind. Das meiste sind Bestellteile, wir bestellen normal nur 1-2x im Monat, da die Versandkosten sehr hoch sind. Wir können aber auch kurzfristig liefern, müssen aber dann das Porto mitberechnen. Normal beträgt die Lieferzeit bis die Teile bei uns sind 2-5 Werktage

www.kutzer.biz

Inhaber:
Boris Kutzer
Steuernummer 168/242/40101
USt-Id.Nr. DE193205919
Änderungen & Irrtümer vorbehalten

Content

03-09	Wössner forged pistons snowmobile
10	Wössner forged pistons Sea-doo
11-15	Crankshafts, shortblocks, oil seals
16-17	Nicasil replated cylinders
18-19	Crankshaft bearing, web, oil seals
19-20	Connection rods, Fett, Nadellager
21-25	Kurbelwellenlager, web, oil seals
26	Kugellager
27-33	Kolben, made in Taiwan
34	Sekundär Variator
35-40	P80, P50, ALT Kupplung und Teile, ATV
41-49	Camoplast Raupen
50-52	Instruction for utility snowmobiles
53	Welle, Counter shafts., Haken
54	No Slip, Sprockets, Idler wheels
55	No Slip, Sprockets, Idler wheels
56-57	Gleitschienen
58	Vergaser adapter
59	Getriebe Zahnräder, Syncro
60-61	Silent und Hyvo Ketten, Zahnräder
62-63	Bremsklötze, hood clamps, Aufkleber
64	Benzinpumpen, Windschutzscheiben
65	Starter-Motoren
66-69	CDI-Zündboxen , ignition coils, reg.
70-73	Extra breite Ski Ski skins, , etc
74-79	Gleitstäbe
80	Hints



03-09 Snowmobile Kolben
10 Sea-doo Kolben



**11-15 Rebuilt
crankshafts**



Lynx - 1996-2017 Schmiedekolben Rotax



Kolben	Bohrung		Engine	Gasket	Oil seals	Nadellager	Ringe
09-7048	65,00	2	453 (440)	710-258	55205	35-505	RST6500
Lynx Racing 440 1998-04, Lynx Rave 440 2005-06							
09-7045	69,50	2	494 Rave	710-212	55190	35-503	RST6950
09-7045-050	70,00		Compression height 32,50 mm				RST7000
09-7045-100	70,50		XR 500LC 2000, Ranger LCE 2001-02				RST7050
Cobra Ultra 1996, Glx 5900 LC 1996-99, Enduro 500 1997-99, Lynx ST 500 2002							
Enduro 500 1997-99, G-Touring 500 1998-00							
09-7028	69,50	2	493 Rave	710-256	55205	35-505	RSB6950
09-7028-050	70,00		Compression height 30,50 mm				RSB7000
09-7028-100	70,50						RSB7050
Lynx 5900 ST 2000, Enduro 500 2001-05, Gr Tour. 50 2001-02, Enduro 500RER -02							
09-7047	76,00	2	593 Rave	710-259	55216	35-507	RST7600
09-7047-050	76,50		ST 600 2002-07, GR Tour. 600 2001-02,				RST7650
09-7047-100	77,00		Enduro 600RER 2002, Ranger LCE 2003				RST7700
Enduro 600 SP 2000-02, Super Touring 600 2001-2003, Lynx 5900 ST 2001							
Ranger 600 2004-06, Adventure 600 2006, Rave 600 2006-							
09-7053	72,00	2	593 Rave RS	710-278	55204	35-507	RST7200
2008-2015; Lynx Rave 600 RS 2008-2015							
09-7021	72,00	2	600 SDI, HO	710-278	55204	35-507	RST7200
			600 E-Tek	710-303	55230		
Enduro 600SP 2003-04, Enduro 600 HO SDi 2004-05, Sport Touring 600 2003-05							
Sport Tourer 600 2003-05, Adventure 600 SDi 2006-08, Rave 600 SDi 2006-08							
XTRim 600 SDi 2006-08, Yeti 600 SDi 2006-08, Rave Re, SC 600 SDi 2007-08							
Gr Tourer 600 SDi 2009-2010, Rave E-Tec 600 2009-2012, XTRim 600 E-Tec 2011-12							
Commander 600 E-Tec 2012-13, XTRim Commander 600 E 2009-2011							
49 Ranger 600 E-Tec 2011, All 600 cc E-Tec engines							
09-7056	78,00	2	670 93-94	710-197	55105	35-524	RST7800
09-7056-050	78,50		670 95-96	710-293	55190		RST7850
09-7056-100	79,00		670 97-00	710-215	55190		RST7900
Rave 670 1994-97, Snow Cross 1996, Grand Touring 1997, Rave Big Pipe 1998-99							
Grand Touring Royal 1998-99, Rave Special 2000, G-Touring 700 2000.							
09-7049	78,00	2	693 2000-02	710-255	55204	35-507	RST7800
09-7049-050	78,50		693 2003-04	710-255	55217		RST7850
09-7049-100	79,00						RST7900
Super Touring 700 2001-02, Enduro 700 2001-02, Enduro 700 RER 2002							

Lynx - Rotax 1996-2017 Schmiedekolben Wössner



Kolben	Bohrung		Engine	Gasket	Oil seals	Nadellager	Ringe
09-7022	82,00	2	793 2003-07	710-261	55217	35-507	RST8200
09-7022-050	82,50		793 2000-02	710-261	55204		RST8250
09-7022-100	83,00		Ranger Mountain 03-04, XTRim PTEk 06-07				RST8300
Rave 800 2001-04, Rave 800 SDi 2005, RC 800 PTEk 2006-07, Enduro 800 2001-02							
Super Touring 800 2002, Sport Touring 800 2003-04, Adventure 800 2005							
09-7060	82,00	2	800 R 2013-	Replace 09-7023			RST8200
09-7060-050	82,50			710-302	55229		RST8250
09-7060-100	83,00			710-312	55229	35-415R	RST8300
09-7060-300	85,00						RST8500
09-7023	82,00	2	800 R	710-302	55229	35-415R	RST8200
09-7023-050	82,50		800 R E-Tek	710-312	55229		RST8250
09-7023-100	83,00		All ETec makes 2008-2016				RST8300
09-7023-300	85,00		Boondocker 800R E-Tec 12-13, Rave 800R E-Tec 12-13				
Rave 800R 08-11, XTRim 800R 2008-2010, Boondocker 800R 2011, GLS 3300 2013							
09-7046	76,00	2	550 F/C	710-277	55215		RST7600
09-7046-050	76,50				03-09	35-524	RST7650
09-7046-100	77,00				10-14	35-507	RST7700
Enduro 550 F 2003-05, Rave 550 2006-2015, 550 SUV 2003, ST 550 2004-07							
Lynx 6900 2004-06, Ranger 550F 2003-09, Explorer 550F 2003-05, Forest Fox 2005							
XTRim 550 2006-2012, Adventure 550 2006-09, Yeti 2008-2011, All 550 2003-2015							
08-6002	82,00	2	Rotax 747 Z	Seadoo 718 piston 1996			
08-6002-050	82,50			Cylinder height 121,3 mm			
08-6002-100	83,00						
08-6001	82,00	2	Rotax 747 Z	Seadoo 780 piston, 1997-00			
08-6001-050	82,50			Cylinder height 123,4 mm			
08-6001-096	82,96						
Lynx Racing 747 Z, 1996-2000 Designed by Totaltek Ky. Ca. 65 pcs							

Ski-doo - Rotax 1996-2017 Schmiedekolben Wössner



Kolben	Bohrung		Engine	Gasket	Oil seals	Nadellager	Ringe
09-7046	76,00	2	550 F/C	710-277	55215		RST7600
09-7046-050	76,50				2003-09	35-524	RST7650
09-7046-100	77,00				2010-14	35-507	RST7700
2003-2015; Summit 550F 2003-08, MXZ 550 F, X 2003-09, Grand Touring 550F 2003							
Legend GT 550F 2004, Scandik WT 550, SUV 2003-09, Alpine IV 2004-05							
GTX 550F 2005-09, Freestyle, Back Country 2006-08, Tundra 2006							
Expedition Sport 2007, Scandik WT 600 2007, TNT 550 F 2010-12							
Renegade 550 Sport 2010-12, Grand Touring Sport 550F 10-12, Scandik Tundra 10-12							



Kolben	Bohrung		Engine	Gasket	Oil seals	Nadellager	Ringe
09-7048	65,00	2	453 (440)	710-258	55205	35-505	RST6500
MXZ 440 LC X 1998-07							
09-7045	Bore 69,50	2	494 Rave	710-212	55190	35-503	RST6950
09-7045-050	Bore 70,00		Compression height 32,50 mm				RST7000
09-7045-100	Bore 70,50		Scandik WT 1998-99, Formula 500 LC 2000				RST7050
Formula Mach Z 3-syl 779 Rave 1993-96, Grand Touring 500 1996-99, MXZ 500 98-99							
Formula SLS 1996, Summit 500 1997-99, Formula 500 DLX 1998-99							
09-7028	69,50	2	493 Rave	710-258	55205	35-505	RSB6950
09-7028-050	70,00		Compression height 30,50 mm				RSB7000
09-7028-100	70,50						RSB7050
MXZ 500 00-03, Touring 500 00-03, Scandik WT 2000							
09-7047	76,00	2	593 Rave	710-259	55216	35-507	RST7600
09-7047-050	76,50		Summit 600 1999-01, MXZ 600 1999-02,				RST7650
09-7047-100	77,00		Formula Z, DLX 600 2000-01				RST7700
Grand Touring 600 2000-03, Scandik 600 WT, SUV 2001-07, Legend GT 500 SS 2004							
MXZ 500 Rev SS 2004-06, GTX 500 SS 2005-07, TNT 2008-09, Summit 500 SS 2009							
09-7053	Bore 72,00	2	593 Rave RS	710-278	55204	35-507	RST7200
2008-2015; MXZ RS 600 2008-2015							
09-7021	72,00	2	600 SDI, HO	710-278	55204	35-507	RST7200
			600 E-Tek	710-303	55230		
Summit 600, RER, Adr. 2003-08, Renegade 600, X 2003-08, MXZ 600 REV-X 2003-06							
Legend GT 600 2004-, GTX 600 2005-08, Expedition YETI 600 SDi 2006-07							
MXZ 600 HO, RS-X 2007-08, Expedition 600 TUV 2008-, MXZ 600 E-Tec 2009-10							
Renegade 600 E-Tec 2009-12, Summit 600 E-Tec Everest, SP 2009-12							
Expedition 600 SDi, LE 2010-12, Grand Touring LE 2012-							
09-7056	78,00	2	670 93-94	710-197	55105	35-524	RTS7800
09-7056-050	78,50		670 95-96	710-293	55190		RST7850
09-7056-100	79,00		670 97-00	710-215	55190		RTS7900
Mach I X 93, Mach I 93-96, MXZ 670 96-98, Grand Touring SE 94-96, Formula SS 95-96							
Formula Z 670 98-99, Summit 670 96-99							
09-7049	78,00	2	693 2000-02	710-255	55204	35-507	RST7800
09-7049-050	78,50		693 2003-04	710-255	55217		RST7850
09-7049-100	79,00						RST7900
Grand Touring 700 2001-, Renegade 700 2002							
Summit 700 2000-01, Formula DLX 700 2000-01, MXZ 700 2001							
09-7022	82,00	2	793 2003-07	710-261	55217	35-507	RST8200
09-7022-050	82,50		793 2000-02	710-261	55204		RST8250
09-7022-100	83,00						RST8300
Summit 800HM, X, 162, Adr. 2000-07, MXZ 800X 2001-02, Renegade 800X 2002-07							
Grand Touring 800 2002-03, MXZ 800 REV-X 2003-07, Legend GT 800, GTX 800 05-07							



Kolben	Bohrung		Engine	Gasket	Oil seals	Nadellager	Ringe
09-7060	82,00	2	800 R 2013-	Replace 09-7023			RST8200
09-7060-050	82,50			710-302	55229	35-415R	RST8250
09-7060-100	83,00			710-312	55229	35-415R	RST8300
09-7060-300	85,00						RST8500
09-7023	82,00	2	800 R	710-302	55229	35-415R	RST8200
09-7023-050	82,50		800 R E-Tek	710-312	55229		RST8250
09-7023-100	83,00						RST8300
09-7023-300	85,00						RST8500
MXZ 800 R X 2008-10, Renegade 800 X-XP 2008-10, Summit 800 X-XP 2008-10							
09-7046	76,00	2	550 F/C	710-277	55215		RST7600
09-7046-050	76,50				2003-09	35-524	RST7650
09-7046-100	77,00				2010-14	35-507	RST7700
2003-2015; Summit 550F 2003-08, MXZ 550 F, X 2003-09, Grand Touring 550F 2003							
Legend GT 550F 2004, Scandik WT 550, SUV 2003-09, Alpine IV 2004-05							
GTX 550F 2005-09, Freestyle, Back Country 2006-08, Tundra 2006							
Expedition Sport 2007, Scandik WT 600 2007, TNT 550 F 2010-12							
Renegade 550 Sport 2010-12, Grand Touring Sport 550F 10-12, Scandik Tundra 10-12							
09-7050	88,00	2	Rotax 997	710-289	55226;	35-430R	RST8800
Renegade 1000 X 2006-07, Mach Z 1000 2006-07, Summit 1000 HM 151, 162, 06-07							

Kolben	Bohrung		Engine	Gasket	Oil seals	Nadellager	Ringe
09-7001	65,00	2	431 F/C	internet	55109	35-502	RSB6500
Jag AFS, 440, 87-99, S. Jag 87-97, Z440 95-98, Bearcat 440,93-00, Panther 440 -01							
09-7002	68,00	2	435 L/C	internet	internet	35-502	RSB6800
Pantera 440 1985-90, El Tigre 5000 440 1987-89							
09-7034	66,50	2	440 L/C	710-273	55203	35-503	RST6650
ZL 440 97-00, Jag 440 96, Cougar 91-94, Cheetah Tour. 91-94, Z 440 ESR 03-04							
09-7004	71,00	2	497 L/C	internet	internet	35-523	RST7100
ZRI 500 1998-2000, Powder Special 500 EFI 2000							
09-7035	71,00	2	499 L/C	internet	55222	35-526	RST7100
ZR 500 01-02, Sabercat 500, EFI, LX 03-06, M5, M5 EFI 05-06,							
F5 EFI, F5 EFI LXR 2007-10, CF EFI 07-09, Snopro 500 2010-13, T500 08-09							
09-7005	73,40	2	550 L/C	710-189	55176	35-523	RST7340
Bearcat 550 -95-2002, EXT 550 1992-96, ZL 550 2000-03							
Pantera 550 1991-2005, Panther 550 1997-2001, Prowler 2-up 1995							
09-7037	75,40	2	581 L/C	710-189	55176	35-523	RST7540
Prowler 580 1996, EXT 580 1993-98, ZR 580 1993-97, Pantera 580 1996-98							

Arctic Cat 1987-2017 Schmiedekolben Wössner

Kolben	Bohrung		Engine	Gasket	Oil seals	Nadellager	Ringe
09-7006	66,50	3	594 3-syl	710-216	55176	35-503	RST6650
Triple Touring 600 1999-2000, ZRT 600 1996-2000							
09-7007	78,00	2	599 L/C	710-227	55176	35-523	RST7800
09-7007-050			Powder Special 600 1998-2000, ZR 600 1998-99				
09-7008	Bore 78,00	2	599 L/C	710-249	55203	35-526	RST7800
Mountain Cat 600 2001-04, Pantera 600 EFI 2002-05							
Powder Special 600 EFI, ZR / ZL 600 EFI 2000-03							
09-7054	73,70	2	600 L/C	710-304	55223	35-507	RST7380
Sno Pro 600 2009-13, Sno Pro 600 Cross country, ZR 6000 Sno Pro R 14- Cyl. 87K1							
09-7061	Bore 73,80	2	600 L/C	??	??	20 mm	RST7380
2014-xx; ZR 6000 Sno Pro RR, M6000, XF 6000 Cylinder 0904005							
09-N/A	73,80	2	600 L/C	710-275	55221	35-526	
2004-2011; Firecat 600, Sabercat 600, M6 EFI, Crossfire 600, F6, M6, CF6							
09-7009	79,70	2	698 L/C	710-275	55221	35-526	RST7970
Sabercat 700 EFI 2004-06, Crossfire7 2006, F7 Firecat 2004-06, M7 2005-06							
09-7010	81,00	2	699 L/C	Internet	55173	35-523	RST8100
09-7010-050	81,50		Powder Special 700 99-00, ZR 700 99-00,				RST8100
09-7010-500	86,00		Wildcat 700 M.C, EFI 91-96, ZL 700 -00				RST8600
09-7011	81,00	2	785 L/C	710-262	55207	35-420A	RST8100
09-7011-500	86,00						RST8600
ZL 800 EFI, ESR 02-03, ZR 800 01-03, Mt Cat 800, EFI 01-04, Pantera 800 EFI 02-04							
09-7012	72,00	3	794 3-syl	710-287	55182	35-523	RST7200
ZRT 800 1995-2001, Pantera 800 1998-99, Thundercat M.C 1996							
09-7038	85,00	2	784 L/C	710-295	55223	35-526	RST8500
F8 EFI Snopro 07-09, M8 Snopro 09, CF 8 Snopro 09, Crossfire 800 07-08, 794cc-09							
09-7059	85,00	2	784 L/C	710-311	55223	35-526	RST8500
2010-2015; CF8 2010- , F8 2010- , M8 2010- , M800 2012- , F800 2012- , XF800 -12-							
09-7030	85,00	2	862 L/C	710-262	55207	35-420A	RST8500
Mt Cat 900 03-04, King Cat 900, EFI, Snopro 04-06, ZR 900, EFI 03-06, ZR 900							
09-7039	76,50	3	895 3-syl	710-193	55173	35-523	RST7650
09-7039-400	80,50						RST8050
09-7039-450	81,00		Thundercat 900 1993-97, Thundercat 900 1993-97				
09-7013	81,00	3	993 3-syl	710-193	55182	35-526	RST8100
09-7013-400	85,00						RST8500
Thunder Cat 1000 M.C 98-02, Mountain Cat 1000 01-02, Pantera 1000 00-01							
09-7014	90,30	2	1000 L/C	710-296	55224	35-420A	RST9030
Crossfire 1000, F1000, M1000 2007-2009							



Polaris Wössner Kolben; ersetzen 09-711, 09-712

09-7063-025	Bore 72,25	2	488 L/C	710-185A	1989-95	55107	35-503
09-7063-050	Bore 72,50		(500)	710-253	2000-14		
09-7063-100	Bore 73,00		Indy 1989-1999, Widetrack 1997-2014				Neu

Kolben	Bohrung		Engine	Gasket	Oil seals	Nadellager	Ringe
09-7040	70,50	2	500 99-01	710-237	55194	35-521	RST 7050
09-7040-050	71,00		500 02-07	710-250	55194		RST 7100
XC 500, SP, X, 1999-03, 500 SKS, E, 00-01, XC 500 SP RACE 2004-06							
09-7015	73,00	2	544 99-03	710-238	55196	35-503	RST 7300
09-7015-050	73,50		544 03-15	710-286	55218		RST 7350
09-7015-100	74,00		Sport Touring, E, 2000-04, Trail Touring,				RST 7400
550 Super Sport Edge 2001-02, PRO X 550 2004, RMK 550 2004-07, DLX 2000-09							
IQ 550 SHIFT, LXT 2010-15, 550 Transport 2010-11, Super Sport, X, 1999-07							
09-7016	74,50	2	600	710-230	55193	35-507	RST 7450
600 XC Special 1998-99							
09-7017	77,25	2	600 00-06	710-251	55194	35-507	RST 7725
77,13 mm			600 07-09	710-297	55219		
			CFI 07-08	710-298	55225		
			IQ 08-12	710-305	55225		
HO IQ Touring CFI 2007-, XC 600 SP, EDGE 2000-07, 600 Classic, PRO X 600 2003-04							
Touring 2001-06, XC 600 X M10 -02, HO IQ 600 CFI 2007-, HO Fusion , IQ 600, 06-07,							
XC 600 SP X 2003-, RMK 600 2004-07, 600 Switchback 2004-07; XC 600 XP RACE 05-,							
09-7062	77,25	2	600	710-307	55225	35-507	RST 7725
77,11 mm ; RUSH 2010-			Note; 61-600R orig p/n			Cylinder 302 2206	
09-7055	73,80	2	600 08-15	710-305	55225	35-526	RST 7380
IQ Racer 600							
09-7018	81,00	2	700 99-01	710-231	55193	35-507	RST 8100
09-7018-050	81,50		700 02-05	710-265	55193		RST 8150
09-7018-100	82,00		XC 700, SP 1999-00, 700 SKS 1999-00,				RST 8200
09-7018-300	84,00		RMK 700 1997-00, INDY XC 700 1998-03				RST 8400
INDY 700 SKS 1998-03, PRO X, X2 700 2003-05, Switchback 700 2004-05							
09-7031	81,00	2		710-298	55225	35-526	RST 8100
Dragon 700 2007-08, RMK 700 2007-2010							
09-7041	77,50		700	710-288	55214	35-526	RST 7750
09-7041-100	78,50						RST 7850
RMK 700, 2006, Fusion 700 2006,							
09-7043	Bore 72,00	3	794	710-254	55186	35-503	RST 7200
XCR 800 3-syl 1999-00							
09-7019	85,00	2	794	710-252	55193	35-526	RST 8500
09-7019-050	85,50		800 RMK 2000-,XC 800 SP EDGE, X, 01-02				RST 8550
09-7019-100	86,00		PRO X 800 2003-04				RST 8600
800 Touring 2004-05, 800 Switchback 2005-09.							
09-7044	85,00	2	800 08-09	710-306	55225	35-526	RST 8500
			800 10-12	710-310	55225		
			800 13-	711-310	55225		
Dragon 800, Assault 800 All, RMK 800, RUSH 800 2009-							
09-7020	83,00	2	900	710-282	22214	35-526	RST 8300
09-7020-100	84,00		900 RMK, Fusion 900 05-06, Sw.back 900				RST 8400



Kolben	Bohrung		Engine	Gasket	Oil seals	Nadellager	Ringe
09-7024	68,00	2	500 L/C	710-200	55188	35-521	RSB6800
Venture 500 1998-01, VMax 500 XTC, DX 1998-, SRX 500 1999, SX 500 R 2000-01							
09-7057	72,00	2	485 F/C			35-505	RST7200
09-7057-050	72,00						RST7250
09-7057-100	73,00						RST7300
Mountain Lite 97-99, Phazer 84-01, Venture 91-03, XL-V 91-93							
09-7058	73,00	2	535		55133	35-521	RST7300
09-7058-050	73,50		SRV-90	710-167			RST7350
09-7058-100	74,00		VK 88-05	710-182			RST7400
EC540 79-84, SR540 80-91, XL540 85-90, VK540 1988-2007, Viking III -2014							
09-7025	74,80	2	598 L/C	710-201	55188	35-521	RST7480
VMax 600 DX, ST, XT, XTC 1994-98, Mountain Max 600 1996-99, Venture 600 97-98							
09-7051	65,00	3	600 3-syl	710-240	55198	35-507	RST6500
SRX 600 1999, Venture 600 1999-04, VMax 600 DX 1999-00, SX 600 R 2000-02							
09-7026	70,50	3	698 3-syl	710-241	55198	35-507	RSB7050
Mountain Max 700 1996-02, VMax 700 XTC, DX 1998-01, Venture 700 1998-03							
SX 700 R 2000-01							
09-7027	69,00	3	696 3-syl	710-246	55199	35-507	
09-7027-100	70,00						
09-7027-400	73,00		VMax 700 SX 1997,				
Mountain Max 700 1999, Mountain SRX 700 1998-99, SRX 700 1998-99							
09-7052	69,00	3	700 3-syl	710-269	55199	35-507	RST9600
09-7052-100	70,00		Venture 700 2004-				
SRX 700 2000-02, SXViper 700, ER 2002-04, SXViper Mountain 2003-04							
09-7501	77,00	2	499	711-299	N/A	35-507	770XAS
Phazer GT 2007, Phazer Mountain Lite 2007, Phazer FX, MTX, FTX, R-TX 2007-10, Phazer Multipurpose 2007, Venture Multipurpose 2008-10, Venture Lite 2008-10							
09-7502	74,00	4	998	711-314	N/A	N/A	740XAS
RX-1 Mountain 2003-04, RX-1 ER 2003-06, RX-1 2003-, RX Warrior 2004-06							
09-7503	75,00	4	1025				
RX-1 Mountain 2003-04, RX-1 ER 2003-06, RX-1 2003-, RX Warrior 2004-06							

**ATV 450 cc Racing
Wössner Kolben**

Can Am	09-8864
Suzuki	09-8699
Yamaha	09-8657

Arctic Cat

Ski-doo, Seadoo

Polaris

Kawasaki

Yamaha

Arctic Cat	Kolben p/n	cyl	cc	bohr.	Dichtung, full set
Arctic Cat					
SX-R800 03-11	08-6010	2	782	82,00	
JS900, ZXI900 95-97,	08-6009	3	891	73,00	08-611502
STX900 96-06, STS900 01-02					
ZXI1100 90-03, STX110097-03	08-6007	3	1071	80,00	
Auch über Größe jeder 0,5 mm					
Ski-doo, Seadoo					
XP/GTI/HX/SPX/GTS/GS/GSI 95-03	08-6002	2	718	82,00	08-611204
Übergröße 0,50 mm	08-6002-050				
Übergröße 1,00 mm	08-6002-100				
Übergröße 1,50 mm	08-6002-150				
Übergröße 2,00 mm	08-6002-200				
XP/SPX/GSX/GTX/GTX/GTI 97-03	08-6001	2	780	82,00	
Übergröße 0,50 mm	08-6001-050		800 Carbu		08-611205
Übergröße 0,96 mm	08-6001-096		800 RFI new		08-611209
GSX-LTD/XP-LTD/GTX-LTD 97-05	08-6011	2	951	88,00	
LRV/RX950 97-05, Sporster950 00-03, VSP950 99-03			951 Carbu		08-611206
Übergröße 0,50 mm	08-6011-050		951 DI		08-611210
Übergröße 1,00 mm	08-6011-100				
Übergröße 2,00 mm	08-6011-200				
Übergröße 3,00 mm	08-6011-300				
Polaris					
SL 700, Virage, 96-04	010-832	2	700	81,00	08-611804
SL 750, SLT, MSX110-150 93-04	010-830	3	750	69,75	08-611802
Octane, Virage 777, 02-04	010-835	3	800	84,00	08-611807
SL 780, SLT 780, 96-97	010-834	3	780	71,50	08-611803
SL 1050, SLX, SLTX, 96-98	010-832	3	1050	81,00	
Genesis 1200, 99-04	010-835	3	1200	84,00	08-611809
Genesis 1200, 02-04	010-835-07	3	1200	85,00	08-611812
Kawasaki					
JS750 SS, SSXi, ST, SX, XIR 92-95	08-6006	3	750	80,00	08-611407
SX-R800 03-11	08-6010	2	800	82,00	08-611409
JS 900, ZXI, STS, STX 95-06	08-6009	3	900	73,00	08-611404
ZXI 1000, STX, Ultra 96-04	08-6007	3	1100	80,00	08-611405
Ultra 150 STX-R, 95-05		3	1200	80,00	08-611411
Yamaha					
Super Jet 700 93-10, Wave Runner	08-6005	2	701	81,00	08-611605
Wave Blaster 700, Wave Venture XL700 02, 700 Marke 93-98					
Wave Runner 1100 95-97	08-6005	3	1100	81,00	08-611604
Übergröße 0,50 mm	08-6005-050				
Übergröße 1,00 mm	08-6005-100				
GP800R 98-05, XL, XLT800 00-04	08-6004	2	800	79,90	08-611607
Übergröße 0,50 mm	08-6004-050				
Übergröße 1,00 mm	08-6004-100				
XL, XLT 1200 98-05	08-6004DD	3	1200	79,93	08-611608
GP 1300R 03-08	08-6003	3	1300	83,90	08-HLYG1300

Shortblock, kit

Available with short delivery time.

Short block includes:

- rebuilt crankcase
- new pistons
- rebuilt crankshaft
- replating cylinders
- new gasket set
- new bearings
- breaking in oil 500 ml
- rotary valve shaft

Note: price does not include core exchange

Kurbelwellen, rebuilt

Rebuilt crankshafts:

- all bearings
- centrum oilseals
- connection rods
- 1-year warranty
- with grease (if needed)

Important notice of the crankshafts

Important:

Allways refer to the engine manufacturer´s shop manual for crankshaft installations.

Before closing the crankcase, make sure that the crankshaft fits firmly in the crankcase.

Before and after installing and torquing crank case bolts, be sure that the crankshaft turns smoothly. You must refer to the engine manufacturer for the proper bearing grease application. Bearings may be damaged if the grease is not applied properly.

Break-in-period:

There is never a more important period in the life of your engine than the break-in period.

For the first 10 hours, do not put an excessive load on the engine. Avoid prolonged full throttle operation. Also avoid lugging the engine such as laborious operation in wet snow. If an abnormal condition is noticed, such as excessive vibration or noise, consult the engine manufacturer´s shop manual.

Warranty:

Rebuilt standard parts will be guaranteed for a period of one year starting at the invoice date.



IMPORTANT NOTICE

CRANKSHAFT INSTALLATION INSTRUCTIONS

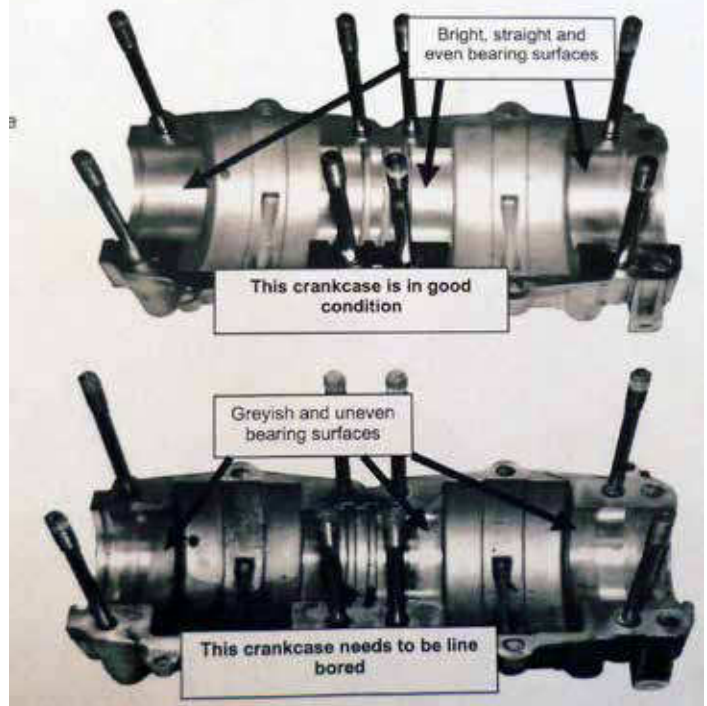

Kurbelwellen-Lagerfett

35-900 Lagerfett 300 g

35-901 Lagerfett 50 g

Verwenden, wenn die PTO und / oder MGT Kugellager ist ein umschlossenen Raum.



Rotax, Lynx & Ski-doo Kurbelwellen, rebuilt

# p/n	cc	Jahre		beachten Sie	Nadellager
1-Zylinder F/C motor					
60-253KA	253	85-92	Citation, Safari, Tundra LT, Lynx 250		35-505
#4210002			Nordik 300, 300R		
60-277KA	277	93-05	#4210030; 420995301; Tundra II, LT, R		35-505
60-277KB	277	06-09	#4210639; 420889630; Scandik, Tundra 300		35-505
2-Zylinder F/C motor					
60-377KB	377-	82-89	Nordik 500, Safari 377, 447, Scout	Nippo	35-505
#4210028	447		Lynx, Trapper 500, Skandic 377		
60-377KC	377-	90-96	Formula S, Nordik 500, Nordik 377R		35-505
#4210009	447		Scandik 377/R, Touring, Lynx		
60-447KA	377-	97-07	Lynx, Formula S/DLX, GTour 380, MXZ 440		35-505
#4210154	447;	420889630;	GSX-GTX 380, Legend 380, Scandic 380/440/LT		
60-503KA	503	79-81	Blizzard 5500, Everest 500, Lynx	breaker	35-505
#4210033					
60-503KB	503	82-89	Alpine 503, Lynx, Trapper 600		35-505
#4210032	#4210155		Scandic 503, Cheyenne, Safari 503		
60-503KC	503	90-96	Alpine II, Lynxit, Nordik 600		35-505
#4210011			Scandic WT, Scandic II, 503R, SLT		
60-503KD	503	97-03	Lynx, Formula S, Legend, MXZ 500		35-505
420996445	420888390/1		Scandic SWT, WT, Touring E, LT, SLE		
60-550KA	550	03-09	Scandic 550, SUV, WT, SWT, MXZ	grease	35-524
#4210601	420 889 062		Freestyle, GSX-GTX, Summit 550	needlecage	
60-550KB	550	10-12	Scandic, Tundra SUV 550, MXZ, TNT	grease	35-507
#4210673	420 889 067		Renegade, GT 550,	needlecage	
3-Zylinder; L/C motor					
60-600KF	700	98-00	Formula III 600 / 700 / 700R	CK3	35-503
#4210311	420888030		Mach I & I R, GT 700 SE / SE ME		
60-600KG		96-97	Formula III 600 / 600LT / 700R		35-503
#4210152			Mach I & I R		
60-809KA	809	97-03	Formula III 800, GT SE ME / 800 SE		35-505
#4210157	420887667		Mach Z (LT, LTR, M.H.R., R)		
4-Takt, L/C					
60-810KA	810V		Scandik Tundra LT-800, Exp, Sport,		
420819355	07-12		Scandik WT, Tundra V800, Exp TUV V-800		
60-1000KV	1000 V2		Expedition V-1000, Legend V-1000		
420889441	03-06		Grand Touring V-1000,		

# p/n	cc	year	make	note	needle
2-Zylinder F/C motor					
60-440KA	440	00-05	MXZ X 440, 440 Racing	grease	35-503
#4210567	500	00-02	Formula DLX, MXZ 500, Legend 500		
60-500KA	494	96-00	Scandic 500 WT, Lynx, MXZ 500	needlecage	35-503
#4210151			Formula Z 500, Summit 500, GT 500		

Rotax, Lynx & Ski-doo Kurbelwellen, rebuilt

L/C; Liquid cooled

# part	cc	Jahre		beachten Sie	Nadellager
2-Zylinders; L/C motor					
60-500KA	494	96-00	Scandic 500 WT, Lynx, MXZ 500	Nadellager	35-503
4210151	420886933		Formula Z 500, Summit 500, GT 500		
60-582KA	582	83-99	Lynxit, Formula STX, DLX, Z583,		35-505
4210021			Plus, Plus X, LT, XTC, Mach I, Summit		
60-600KA	500ss	03-12	Lynx WT, SUV, Scandic 600, MXZ 600	grease, 66 mm	35-507
4210011	420888757		MXZ SS, GTX SS, all SS engines	centrum seal	
60-600KB	600	1999	MXZ & Summit 600	grease, 62 mm	35-507
4210553	420888250			centrum seal	
60-600KC	600	00-02	Formula DX, Z600, Scandic 600	grease, 62 mm	35-507
4210563	420888252/1		MXZ, Legend 600, Summit 600	centrum seal	
60-600KD	600ho	03-07	Summit 600HO, Renegade 600HO/X		35-507
4210609	420889091		MXZ 600, Rev 600HO		
60-600KR	600rs	08-10	MXZ MXZ X 600 RS	grease	35-507
4210576					
60-600KS	600rs	12-	MXZ MXZ X 600 RS		35-507
4210636			Plastic block on WEB, no warranty		
60-600KE	600	04-12	420890950/1, All SDI engines	grease	35-507
4210622	4210664, 420890956/5/4;		All ETek engines	key 12 o'clock	
60-670KB	670	95-99	Formula SS, Z670, MXZ 670	key 06 o'clock	35-507
4210046			Mach 1, Summit 670, Lynx	Nadellager	
60-700KA	700	99-00	MXZ 700, Summit 700	grease, 79 mm	35-507
4210570				centrum seal	
60-700KB	700	2000	MXZ 700, Formula 700 DLX, Z700	grease, 76 mm	35-507
4210569			Summit 700 SB, HM, Lynx	centrum seal	
60-700KC	700	01-02	Formula DLX, Legend 700	grease, 76 mm	35-507
421000574	420888266		GT 700, MXZ, Summit 700, Lynx	centrum seal	
60-600KD	700	03-07	GT 700, MXZ, Summit 700,	grease, 76 mm	35-507
4210609	420889091		Legend 700, Lynx	centrum seal, 2x PTO shim	
60-800KA	800	00-02	GT 800, Legend 800, MXZ 800	grease, 76 mm	35-507
4210573	420888402		Summit 800, HM, Lynx	centrum seal	
60-800KC	800	04-07	GSX-GTX 800HO, MXZ 800HO	grease, 76 mm	35-507
4210607	420889671		Renegade 800/X, Summit 800/X	centrum seal, 1 x shim, 1 x sg	
60-800KB	800	03-04	SDI, Grand Touring 800 SDI	grease, 76 mm	35-507
4210606	420889106		Legend 800 SDI	centrum seal, key 12 o'clock	
60-800KR	800R	06-08	All 800 R engines	grease, shim	35-415R
4210665	420892562			centrum seal, key 02 o'clock	
60-800KP	800	09-12	All PTEK engines	grease, shim	35-415R
4210668	420892567		420893090; 420893093; 420893098	seeger, key 12 o'clock	
60-1000KA	1000	05-07	All 1000 SDI engines	grease 100 g.	35-430R
4210634	420889217				

Polaris Kurbelwellen, rebuilt

# p/n	cc	Jahre		beachten Sie	Nadellager
Z-cylinders F/C motor					
61-500KA	440-	kaikki	Sport, SKS, Touring		35-503
#3084585	500		Super Sport, Transport, XCF		
61-550KA	440-	02-15	440 XCF, kaikki 550 mallit		35-503
#3089483	500				
2-Zylinders L/C					
61-440KA	440	98-03	440 Pro X	6 dents	35-503
#2201865					
61-500K	440-	86-95	440 L/C, Widetrack LX	PTO seal 30	35-503
#3084612	500		500 SKS, Carb, EFI, Classic, Touring	square key	
61-500KB	500	96-00	440 L/C Indy, 500 RMK, SKS, Classic	stefa Pto 32	35-503
#3085206	CARB	EFI	Classic Touring	square key, Fuji	
61-500KC	500	00-15	Wide Track, 500 Classic/Indy	stefa Pto 32	35-503
#3089530				moon key, big bearing MGT	
61-500KD	500-	98-03	440 XCR, XC, SP, 500 XC, SP, RMK	6 dents	35-507
#2201234	600		600 Touring, XC, SP, Pro X, RMK	big brass gear	
61-600KK	600-	97-98	RMK, SKS, XC	solid center	35-507
#1201663	700				
61-600KA	500-	04-09	500/600 XP, 600 EDGE, 600 RMK,	10 dents	35-507
#2202520	600		IQ, Switchback, Pro X, Fusion	small brass gear	
61-600KB	600ho	07-13	600 Cleanfire makes, Rush 600	10 dents	35-507
#2203320	2204098		600/700 IQ Dragon -08, Widetrack	small brass gear	
61-700KA	700	07-10	600/700 RMK, 700 IQ Dragon	10 dents	35-507
#2203578			600/700 Switchback		
61-700KB	600-	99-05	600/700 RMK/XC/XC SP	10 dents	35-507
#2201361	700		600/700 XC/DLC/Classic		
61-700KC	700-	2006	700 Fusion, 700 RMK		35-526
#2203110	900		900 Fusion		
61-600KR	600	08-09	600 IQ Racer		35-507
#2203803					
61-800KA	800	08-13	800 Dragon, IQ, Rush, Assault	10 dents	35-526
#2203717	2203993, 2204621;		IQ Racer 2009-13		
61-800KB	800	00-05	800 RMK	solid center	35-526
#2201554			heavy duty bearings on PTO		
61-800KC	600	12-14	600 IQ Racer 2013-		35-526
#2205648	800	2015-	RMK, Rush, Switchback, ProX makes, Axys		



Kurbelwellen, rebuilt

ARCTIC CAT

2-cylinders F/C				beachten Sie	Nadellager
63-570KA	570	02-09	Bearcat 570 / 570 XT ; F570 ; Z570	PTO bolt	35-503
#3006-005			Panther 570, Mountaincat 570	1/2" x 20 x 5 1/2	
63-570KB	570	10-15	F570/ Bearcat 570/ 570XT/ T570	M 12x 157 mm	35-503
#3007-864					
2-cylinders L/C					
63-440KD	440	96-98	ZR 440; ZR 440 Sno Pro		35-520
#3005-258					
63-580KA	550-	93-05	580 EFI/ Bearcat/ Bearcat WT		35-523
#3005230	580		580 Panther		
63-600KA	5-600	98-03	Powder Special 500-600		09-523
#3005-414			ZL/ZR 500-600; EFI; LE		
63-700KF	6-700	00-09	CF600, CF700, Firecat 600/700		B1074
#3306-718	#3006-502		M6-M7, Pantera 600, Sabercat 6-700	#3007-330	
63-800KA	800	07-10	800 EFI, 800 LE, CFR 800, M8		35-526
#3007-529			Crossfire 800 EFI, F8, R800		
63-800KB	800	10-15	SnoPro,CFR8,M8,F8, EFI-XF		35-526
#3007-879					

Kurbelwellen, rebuilt

YAMAHA

# p/n	cc	Jahre		beachten Sie	Nadellager
2-cylinders F/C					
62-340KA	340	77-99	CS 340, ET 340, ET 300, GPX 340		35-522
#34X114000			GS 338, SL 338, SS 338, EX 340		
62-485KA	485	84-98	PZ 480, PZ 500, VT 500, VT XL		35-505
#8VO114000			PZ ML, PZST, VT 480		
62-540KA	535	79-13	EC540, SR540, XL540		35-521
#8H8114000	540		Viking II ja III all makes		
2-cylinders L/C					
62-570KA	570	87-96	EX 570, EX 570 SX		35-507
#82M114000	500, 600	L/C			
62-600KA	500-	97+	Venture 500/600, SX 600, SXR 500		35-507
#82R114000	600		Venture Lite 500, Mountain Max 600		
3-cylinders L/C					
62-700KA	700	02-06	SXV Viper / ER		35-507
#8EK114000					
62-700KB	600-	97-06	MM600, MM700/700 SRX, VMX 600, DLX / VMX 700		
#8CH11400	700		Huom A: VT 600-700, Venture / SX 600 Venom, ER		

Kurbelwellenwange, Rotax

09-1880	Rotax 670	pin 24 mm
09-1881	Rotax 800HO	pin 27 mm
09-1882	Rotax 500 + 600	pin 24 mm
09-1883	Rotax 600 + 700	pin 27 mm
09-1884	Rotax 800R	pin 30 mm

SKI-DOO

LYNX



Nikasil plattiert Zylinder



An old core is always needed for **Nicasil** replated cylinders:
 -not broken shirt
 -also modified, marked
 -to be welded,

Life time warranty (conditional)

Photo: Sarre Oy



Rotax	part no:	Jahre	make
60-440A	923720	99-06	440 MXZ X 440 Racing
60-550A		03-13	550 F/C, note: 0,50 mm od, f.ex. Wössner
60-550B		03-13	550 F/C, note: 1,00 mm od, f.ex. Wössner
60-597A	Rotax SS 600		597 L/C, note: 0,50 mm od, f.ex. Wössner
60-600A	613710	03-06	613712, 613714, 600 HO engine
60-600B	613940	04-07	613942, 613944, 600 HO SDI engine
60-600C	623262	2009	600 E-Tek,
60-600E	263262	2010	600 E-Tek; A hole in the power valve for lubrication
60-600E	623263	2010-	600 E-Tek, same as 623262
60-600F	623480	08-10	600 RS
60-600FA	623481	2011	600 RS
60-600FF	623482	2012	600 RS
60-600FFF	623483	2013-	600 RS
60-700B	923691	2000	700 pin 8 mm
60-700C	923692	00-04	923693, 923695, 700 pin 10 mm
60-800A	923813	03-04	800 SE SDI, Legend, Grand Touring
60-800B	923810	00-04	800 MXZ, Legend 800, Summit 800 HO
	923811		923815, 923817
60-800D	613852	05-07	800 HO PTEK, Ardenaline, Renegade, Summit
60-800R	623240	07-09	800R, monobloc MXZ X 800 R
	623241		6 mm exhaust bolts, use 8 mm bolts
60-800E	413041	07-15	
60-800S	623242	07-11	800R, PTEK, monobloc
60-800T	623246	07-15	800R, PTEK, Techmaster, 8 mm exhaust bolts,
60-800T	623249	07-15	800 R E-Tek, monobloc (623246)
	413042	07-13	
60-800E	413046	07-15	Everyone can be replaced by 60-800E
60-1000A	613744	06-07	Mach Z 1000 SDi
60-1000B	613746	06-07	Summit 1000 SDi, MXZ Renegade 1000



Nikasil plattiert Zylinder

Yamaha				
62-500A	8CJ1131100	8CJ	97-01	VMAX 500, SX500R, XTC, XTR
62-600A	8DG1131100	8DG	99-06	SX600, VMAX600, Venture 600
62-700A	8CH1131100	8CH	97-03	SX700, VMAX700, Venture 700
62-700E	8EK1131100	8EK	02-06	SX Viper, Venture 700

Nicasil Replated Cylinders

Polaris	part:	Jahre:	make
61-440A	3086974	00-01	XCF Edge, XCF SP Edge
61-440B	3021604	05-07	440, IQ440
61-440C	3021304	02-04	440, PRO X 440
61-500B	3021185	2001	500, XC SP
61-500C	3021256	2002	500, XC SP, M10
61-500D	3021334	03-07	500-600, XC SP, EDGE
61-550A	3089934	07-15	550, Edge, 550 IQ, Supersport, Trail
61-600A	3021008	98-01	600 Edge, RMK 600, 600 XC, XC SP
61-600B	3021087	00-01	600, XC PRO X 2000-2001
61-600C	3021257	2002	600, XC PRO X 2002
61-600D	3021333	03-06	600, PRO X
61-600E	3021542	06-09	600, HO, Fusion, RMK, IQ, RR
61-600G	3021718	07-15	600, HO IQ Cleanfire, IQ LXT
61-600R	3022206	10-15	600, Rush, Widetrack IQ
61-600S	3022305	12-15	600, RMK, Rush, Switchback
61-700A	3021866	08-11	600-700, RMK, Dragon, Switchback
61-700B	3021220	97-98	700, RMK, SKS, XP
61-700C	3021824	99-01	700, RMK, SKS, XC, XC SP, XC DLX, Classic
61-700K	3021367	04-05	700, Pro X, XC SP, XC Edge
61-700R	3021767	07-08	700, RMK, Dragon, Cleanfire
61-800A	3022201	2010	800, Dragon, Assault, Switchback, IQ
61-800B	3021064	00-01	800, RMK, XC SP
61-800C	3021329	2002	800, XC SP
61-800D	3021339	02-05	800, Pro X, RMK, XC Edge, XC SP, Pro XC
61-800H	3021843	08-09	800, monoblock, Assault RMK, 800 Dragon SP, IQ
61-800R	3022205	2011	800, monoblock, Assault, Rush
61-800S	3022352	2012	800, monoblock Assault, Rush, RMK
61-800T	3022449	13-16	800, monoblock Assault, Rush, RMK,
61-800X	3022554	15-16	800, Pro-X kaikki vaihtoehdot
61-900A	3021563	2006	900, Fusion, Injection on cylinder
61-900B	3021576	05-06	900, Fusion, RMK



Arctic Cat

63-370A	3005453	8847	99-08	Z370, Panther 370
63-440A	3005001	8842	97-06	Bearcat 440, Jag 440, Z440, Panther 440
63-500A	3006422	95B0	03-06	500, Firecat 500, SP
63-500B	3006745	95B2	04-12	F5, M5, Sabercat 500
63-570A	3005999	94B0	02-15	570, Bearcat 570, Z570, Panther 570
	3007479	94B2		
63-600A	3005653	88BA	01-05	600, ZL-ZR 600 EFI, Pantera 600 Efi
63-600B	3006643	96B0	04-11	600, Firecat 600, Sabercat 600, M6 Efi
63-600D	3007717	87K1	09-14	600 SP, Cross Country
63-700B	3006492	96B1	03-06	700, CF 700, Firecat 700, Sabercat 700
63-800B	3007522	98B0	07-09	CF800, F8, M8 EFI
63-800C	3007849	98B4	10-16	800, CF8, CF 8 Snopro, M8, F8 LXR

1-cylinder F/C	year	PTO	Center	MGT	needle
253	1985-		722-2500		35-505
2-cylinders F/C					
377-447	1990-07	722-2503		722-2503	35-505
503	1979-	722-2504		722-2504	35-505
550	2003-	722-2515		722-2515	35-524
2-cylinders L/C					
440-500	2000-06	722-2505AP		722-2505AM	35-503
434-444	1975-80	722-2504		722-2504	35-505
462	1986	722-2504		722-2504	35-505
494	1996-00	722-2505AP		722-2505AM	35-503
500	2003	722-2505AP		722-2505AM	35-503
521-532-536	1983-99	722-2505		722-2505	35-505
537-582-583	1983-99	722-2505		722-2505	35-505
500SS-600	2003-11	722-516AP		722-516AM	35-507
600, 600HO	1999-07	722-2510		722-2509	35-507
500SSXP-600	2008-10	722-2510		722-2509	35-507
600 HO SDI	2004-11	722-2510		722-2509	35-507
600 HO E-Tec	2004-15	722-2510		722-2509	35-507
617-643	1991-92	722-2505		722-2505	35-505
670	1993-99	722-2507		722-2506	35-507
700	1999-00	722-2507		722-2506	35-507
700	2001-02	722-2510		722-2509	35-507
800 HO, SDI	2000-06	722-2510		722-2509	35-507
800 R, PTEK	2007-15	722-2520		722-2520	35-415R
800 E TEK	2012-	722-2520		722-2520	35-415R
1000 SDI	2005-07	722-2518		722-2518	-

Connection rods, dimensions, Rotax

P/N	Leng. C-C	upp dia	low dia	up wi.	low wid	pin dia.	pin length	upper bearing	lower bearing
722-2500	115	22	30	13	13	24	48	18x22x22	24x30x13
722-2503	115	22	30	15	15	24	47	18x22x22	24x30x15
722-2504	120	22	30	15	15	24	48	18x22x22	24x30x15
722-2505	125	22	31	17	17	24	52	18x22x22	24x31x17
722-2505AP	125	22	30	17	17	24	53	18x22x22	24x30x17
722-2505AM	125	22	30	17	17	24	55	18x22x22	24x30x17
722-2506	132	25	31	17	17	24	53	20x24x23	24x31x17
722-2507	132	25	31	17	17	24	55	20x24x23	24x31x17
722-2509	132	25	35	18	18	27	53	20x25x23	27x35x18
722-2510	132	25	35	18	18	27	55	20x25x23	27x35x18
722-2515	125	25	31	20	17	24	50	20x25x23	24x31x17
722-2518	144,5	29	40	23	23	30	64,80	24x29x23,4	30x40x23
722-2520	132	27	40	20	20	30	57	22x24x24,8	30x40x20
722-516AP	125	25	30	17	17	24	55	18x22x22	24x30x17
722-516AM	125	25	30	17	17	24	53	18x22x22	24x30x17

Connection rods



Polaris Connection rod

2-cylinders F/C					
cc	year	PTO	Center	MGT	needle
440-500	kaikki	724-2513		724-2512	35-503
550	2004-	724-2516		724-2516	35-503
2-cylinders L/C					
440	1993-97	724-2513		724-2512	35-503
500	1993-11	724-2513		724-2512	35-503
500-600	1998-09	724-2517		724-2517	35-507
600-700	1997-01	010-535		010-535	-
800	2000-05	010-538		010-538	35-526

Yamaha Connection rod

2-cylinder F/C					
535-540	1979-06	010-523		010-523	35-521
2-cylinder L/C					
500-570-600	1987-96	010-525		010-525	35-507
500-600	1997-	010-525		010-525	35-507

Arctic Cat Connection rod

2-cylinders L/C					
800-900, ZR900	2001-2008	721-2500		721-2500	

Connection rods, dimension, Polaris, Yamaha, Arctic Cat

P/N	Pit. C-C	up dia	low dia	upp wid.	low widt.	pin dia.	pin lengt	upper bearing	lower bearing
724-2510	112	20	32	16	16	24,3	49	16x20x22	24,3x32,3x16
724-2512	112	23	32	16	16	24,3	56	18x23x22	24,3x32,3x16
724-2513	112	23	32	16	16	24,3	57	18x23x22	24,3x32,3x16
724-2516	120	23	32,3	16	16	24,3	57	18x23x22	24,3x32,3x16
724-2517	128	25	35	17	17	28	/	20x25x23	28x35x17
010-535	125	25	35	16	16	28	60	20x25x22	28x35x16
010-538	136	27	35	18	18	27	60	22x27x25	27x35x18
010-523	120	25	31	20	20	24	59	20x25x24	24x31x20
010-525	125	25	32	20	20	25	60	20x25x24	25x32x20
721-2500	146,5	25	39	22	22	30	/	24x29x23,8	30x39x22

Crankshaft web, Polaris

09-241	Polaris XC500+XC600	pin 28 mm
09-185	Polaris XC800	pin 27 mm
09-186	Polaris XC700	pin 28 mm



Dichtung



09-501731



09-501909



09-501731	30 X 42 X 7 (09-113) Rotax
09-167	30X62X7/8 Rotax
09-501372	35 X 72 X 7/8 (09-165) Rotax
09-501497	40 X 80 X 7 (09-170) Rotax
09-190	ATS DUO 34.6x76x2.6/10.2, centrum
09-501622	40 X 84 X 2,6 / 10,2 Rotax, centrum
09-501584	35 X 72/76 X 7/9 Polaris
09-501909	24 X 44 X 11,4 Polaris
09-501414	30 X 62 / 63,7 X 7 (14202) Polaris



09-501622

09-501372



09-501497



09-501584



09-190

Nadellager

P/N	P/N	dimension	für Kolben
35-502	B1008	16 x 21 x 20	692,696,
35-503	B1014	18 x 23 x 22	601, 691, 693, 694, 695, 699, 774, 781, 782, 707, 710, 711, 712, 713, 715,718,719,727,
35-505	B1003	18 x 22 x 22	740,741,742,746,747,748,750, 751, 752, 758,759, 760,761,762, 763,772,780,800,801,803,804, 806, 807, 810, 811, 812, 813, 814, 815
35-507	B1031	20 x 25 x 22,8	776, 778, 783, 785
35-513	B1016	16 x 20 x 20	706,708,670,
35-514	B1013	15 x 19 x 20	745,
35-520	B1014	18 x 23 x 21	700,702,703,704,705,
35-521	B1023	20 x 25 x 24	808, 816,817,818,825,826,
35-522	B1021	16 x 20 x 22,5	689,802,
35-523	B1024	20 x 26 x 24	602,679,681,682,683,684,687,
35-524	B1072	20 x 24 x 22,7	773,779,
35-525	B1021	16 x 20 x 21,7	685,709,714,716,717,
35-526	B1030	22 x 27 x 25	730,
35-415R		21 x 27 x 24,7	09-7023, 09-7060 800R
35-420A	B1085	24 x 29 x 26	09-7011, 09-7014 AC
35-430R	3008-583	24 x 29 x 23,7	09-7050



Sea-doo; Kurbelwellenlager

Sea-Doo	year	PTO	Centre		MGT
587 L/C bag labyr. tai T-Crank	88-96	6207NCR4 X 2	6206NCR4	6206NCR4	6206NCR4 x 2
650 L/C	93-96	6207NCR4 X 2	6206NCR4	6206NCR4	6206NCR4 X 2
717 L/C	95-05	6207PC4 X 2	6206PC4	6206PC4	6206PC4 X 2
787 L/C Big gear, 787 L/C	95-99	6306PC4, 6207PC4	6207PC4	6207PC4	6207PC4 X 2
951 L/C, 947 DI Big gear	98-05	6208PC4 x 2	6306PC4	6208PC4	6208PC4 X 2
Arctic Cat					
639, 640 L/C 2-cyl		6207PC4	6207GPC4	6207PC4	6207PC4
770 L/C 2-cyl		85B551A35mm	85B551A35mm	85B551A35mm	85B551A35mm
900, 1000, 1100 L/C 3-cyl		6209/1DRIN	6209/1DRIN x2	6209/1DRIN x2	6306/1DYRI
Kawasaki					
JS 440- JS 550	86-95	6206NRC4	6305NRC4	6305NRC4	6206NRC4
JS 650 thread 18 mm	92-97	6306C4	6306C4	6306NRC4	6306C4
JS 750, JS 800, 2-cyl		6306NRC4	6306NRC4	6306NRC4	6306NRC4
JH 900 3-cyl		6307PC4	6207PC4 X 2	6207PC4 X 2	5207PC4
JH - JT 1100, JS 1200 3-cyl		6307PC4	6207PC4 X 2	6207PC4 X 2	5207PC4
Polaris 3-cyl					
700 L/C USA	97	6027C4 X 2	6207C4	6207NRC4	6207C4 X 2
800 L/C	02-04	6207C4 X 2	6207C4	6207NRC4	6207C4 X 2
650 - 750 - 780 L/C	92-97	6307GPC4	6207PC4 X 2	6207PC4 X 2	6207PC4 X 2
785 SP BLACK ENGINE		6307GPC4	6207PC4 X 2	6207PC4 X 2	6207PC4 X 2
900 - 1050 L/C USA	96-98	6207C4 X 2	6207C4 X 2	6207C4 X 2	6207C4 X 2
1200 L/C		6207C4 X 2	6207C4 X 2	6207C4 X 2	6207C4 X 2
Yamaha					
650 - 700 - 760		83A726-E	6207R9	6207R9	83B207
800 2-cyl		6308GPC4	6208PC4	6208PC4	5207PC4
1100 - 1200 3-cyl		83A726-E	6207R9 X 2	6207R9 X 2	83B207 S
1200 GR 3-cyl		6308GPC4	6208PC4 X 2	6208PC4 X 2	OEM

Part number Dimensions

6206PC4	30 x 62 x 16	5207PC4	35 x 72 x 27	83A726-E	35 x 80 x 21
6206NRC4	30 x 62 x 16	6305NRC4	25 x 68 x 17	83B207	32 x 72 x 30
6207C4	35 x 72 x 17	6306/1DYRI	30 x 75 x 19	85B55135mm	35 x 75 x 17
6207PC4	35 x 72 x 17	6306C4	30 x 72 x 19	6209/1DRIN	45 x 90 x 19
6207R9	35 x 72 x 17	6306PC4	30 x 72 x 19	6308GPC4	40 x 90 x 23
6207NRC4	35 x 72 x 17	6307PC4	35 x 80 x 21		
6208PC4	40 x 80 x 18	6307GPC4	35 x 80 x 21		

Kurbelwellen web, snowmobiles

- 09-1880 Rotax 670**
- 09-1881 Rotax 800HO**
- 09-1882 Rotax 500 + 600**
- 09-1883 Rotax 700**
- 09-1884 Rotax 800R**



Polaris

- 09-241 Polaris XC500+XC600**
- 09-185 Polaris XC800**
- 09-186 Polaris XC700**



Rotax = Lynx, Ski-doo

Kurbelwellenlager

Crank	1-CYL F/C		MAG	CENTER	PTO
4210001	247 F/C ELAN	85-96	83464C (6305C4)		83464C (6305C4)
4210002	253 F/C	85-92	6206 GPC4 (NR)		6206 GPC4
4210031	277 F/C	93-05	6206 C4		6306 PC4
4210639	277 F/C	06-09	6206 C4		6306 PC4
	2-CYL F/C				
4210028	377-447 Nippon D	82-89	6207 GPC4	6305 NRC4 x 2	6206 GPC4 x 2
4210009	377-447 F/C	90-96	6207 GPC4	6207 GPC4 x 2	6207 PC4 x 2
4210154	377-447	97-07	6207 GPC4	6207 GPC4 x 2	6207 PC4 x 2
4210033	503 Breaker	79-81	6207 GPC4	6305-NRC4 x 2	6206 GPC4 x 2
4210032	503 Nippon D	82-89	6207 GPC4	6305 NRC4x6206 GPC4	6206 GPC4 x 2
4210011	503 F/C	90-96	6207 GPC4	6207 GPC4 x 2	6207 GPC4 x 2
4210155	503 F/C	97-03	6207 PC4	6207 PC4 x 2	6207 PC4 x 6207 GPC4
4210601	550 Top needle	03-09	6207 GPC4	6207 PC4 x 6207 PC4	6207 GPC4x6207GSPC4
4210673	550 F/C	10-14	6207 GPC4	6207 GPC4 x 6207 PC4	6207 GPC4x6207GSPC4
	2-CYL L/C				
4210567	440 MXZ-X, 500	00-05	6206 PC4 x 2	6206 PC4 x 2	6207 PC4 x 2
4210016	444 L/C	75-80	6206 GPC4	6305 NRC4 x 2	6206 GPC4 x 2
4210150	454 L/C	95-98	6206 PC4 x 2	6206 PC4 x 2	6207 PC4 x 2
4210017	462 L/C SP-SS	84-86	6206 GPC4	6305 NRC4x6206 GPC4	6206 GPC4 x 2
4210019	467 L/C	85-95	6206 GPC4 x 2	6305 NRC4x6206 GPC4	6207 GPC4x 2
4210151	494 L/C T-Crank	96-00	6206 PC4 x 2	6206 PC4 x 2	6207 PC4 x 2
4210599	500 L/C	03	6206 PC4x804551	6206 PC4 x 2	FAG x 6207 PC4
4210021	532-536-582-583	85-99	6206 GPC4 x 2	6305 NRC4x6206 GPC4	6207 NRC4 x 2
4210553	600 L/C C-Seal 63	1999	6206 PC4 x 2	6206 GPC4 x 2	6207 PC4 x 2
4210563	600 L/C C-Seal 66	00-02	6207 PC4 x 2	6206 GPC4 x 2	804661BL178x6207PC4
4210611	500SS, 600 C-S 66	2003-	804551x6206 PC4	6206 PC4 x 2	804661BL178x6207PC4
4210576	600 MXZX RS	2008-	6207 PC4 x 2	6207 PC4 x 2	804662E x 6208 PC4
4210609	600 HO C-Seal 76	03-07	FAG x 6207PC4	6207 PC4 x 2	804661BL178x6207PC4
4210622	600/593 E-Tec	All	FAG x 6207PC4	6207 PC4 x 2	6208X x 804662E
4210023	617-643 L/C	91-92	6206 GPC4 x 2	6305 NRC4x6206 GPC4	6207 GPC4 x 2
4210046	670 L/C	95-99	6206 PC4 x 2	6206 PC4 x 2	6207 GPC4 x 2
4210570	700 L/C C-Seal 79	99-00	6207 PC4 x 2	6207 PC4 x 2	6208 PC4 X 2
4210569	700 L/C C-Seal 76	2000	6207 PC4 x 2	6207 PC4 x 2	6208 PC4 x 2
4210574	700 L/C Mgt seal	01-02	FAG x 6207PC4	6207 PC4 x 2	6208 PC4 x 2
4210609	700 L/C C-Seal 76	03-05	FAG x 6207PC4	6207 PC4 x 2	6208 PC4 x 804662E
4210573	800 L / C	00-02	FAG x 6207PC4	6207 PC4 x 2	6208 PC4 x 2
4210607	800 L/C HO	04-06	FAG x 6207PC4	6207 PC4 x 2	6208 PC4 X 2
4210606	800 L/C HO SDI	03-04	FAG x 6207PC4	6207 PC4 x 2	6208X x 804662E
4210608	800 L/C	2003	FAG x 6207PC4	6207 PC4 x 2	6208X x 804662E
4210665	800 L/C R PTEK	07-08	FAG x 6207PC4	6207 PC4 x 2	6208X x 804662E
4210668	800 L/C E TEK	09-14	FAG x 6207PC4	6207 GSPC4 x 2	6208X x 804662E
4210634	1000 L/ HO	05-07	804662E x 2	6208 PC4 x 2	804662E x 2
	3-CYL L/C				
4210152	600 L/C	96-97	6208-PC4	6206 PC4 x 4	6208 PC4 x 2
4210311	600-700 L/C CK3	98-00	6208-PC4	6206 PC4 x 4	6208 PC4 x 2
4210048	779 L/C	93-96	6208-PC4	6207 GPC4x 4	6208 PC4 x 2
4210157	809 L/C	99-03	6208-PC4	6207 PC4 x 4	6208 PC4 x 2

Part number
Dimensions**Rotax****Part number****Dimensions**

Part number 35-	Dimensions	Parts number 35-	Dimensions
6305 C4 = 83464 C	25 X 62 X 17	6207 C4	35 X 72 X 17
6305 NRC4	25 X 62 X 17	6207 PC4	35 X 72 X 17
6306 NRC4	30 X 72 X 19	6207 GPC4	35 X 72 X 17
6206 C4	30 X 62 X 16	804551 = 6206 GSPC4	30 X 62 X 18/19
6206 PC4	30 X 62 X 16	804662E = 6208 GSPC4	40 X 80 X 21
6206 GPC4	30 X 62 X 16	6208 PC4	40 X 80 X 18
FAG = 804661BL178	35 X 72 X 17/18	6208X = 6208X28YR1N	40 X 80 X 23
FAG = 6207 GSPC4	35 X 72 X 17/18	6208 GSPC4	40 X 80 X 21

Part number
Dimensions**Yamaha Kurbelwellenlager**

Crank	1-CYL F/C		MGT	CENTER	PTO
8R4114000	250 BRAVO	82-10	6305 H/INDY		6306 N9C4
	2-CYL F/C				
34X114000	300-340 F/C	77-99	83464-C	83548D-9	6306 N9C4
1GU114000	400-410 F/C	89-95	83464-C	83548D-9 x 83548D-9	OEM N/A
8K4114000	440 SS	80-84	83548D9	6206B/32C4 x 2	DG3278JSOx2
8VO114000	485 F/C	84-98	DG3268-B	DG3268-B x DG3268-B	83A779 x 2
8DU114000	500 F/C	99-02	DG3268B	DG3268-B x DG3268-B	83A779 x 2
8H8114000	535-540 F/C	79-06	83548D9	83548D-9 x 83548D-9	DG3278JSOx2
	2-CYL L/C				
82M114000	500-570-600cc	87-96	83B207	6207R9 x 6207R9	83A7269 x 2
82R114000	500-600 L/C	97-	83B207	6207R9 x 6207R9	6206B / 32C4
	3-CYL L/C				
8CH114000	700 L/C SX	97-06	62/32GPC4 x 2	62/32GPC4 x 2 x OEM	OEM N/A
	600-700 SX	98-06	OEM N/A	OEM N/A	OEM N/A
	600-700 SRX	98-99	OEM N/A	OEM N/A	OEM N/A
	600-700 SRX	00-02	OEM N/A	OEM N/A	OEM N/A
8EK114000	700 L/C VIPER	02-06	OEM N/A	OEM N/A	OEM N/A
	4-CYL L/C		LEFT	CENTER-GEAR CENTER	RIGHT
8AX11401	750 / 8AX-11401	92-94	6206PC4	6206PC4 x 4 x 6305GPC4	OEM N/A
8AX11402	750 / 8AX-11402	92-94	6206PC4	6206PC4 x 4 x 6305GPC4	83464C
8BU11401	800 / 8BU-11401	95-97	6206PC4	6206PC4 x 4 x 6305GPC4	OEM N/A
8BU11402	800 / 8BU-11402	95-97	6206PC4	6206PC4 x 4 x 6305GPC4	OEM N/A

Part number
Dimensions**Part number****Dimensions**

Part number 35-	Dimensions		Parts number 35-	Dimensions
6206 C4	30 X 62 X 16		83464C	25 X 62 X 17
6206 PC4	30 X 62 X 16		83A779	32 X 78 X 19
6305 H/INDY	25 X 68 X 17		83548D-9	32 X 62 X 16
6306 NRC4	30 X 75 X 19		83B207	32 X 72 X 30
6206 N9C4	30 X 72 X 19		DG3268-B	32 X 68 X 16
62/32 GPC4	32 X 65 X 17		DG3278JSO	32 X 78 X 16,5

Part number
Dimensions

Polaris Kurbelwellenlager

Crank	2-CYL F/C		MGT	CENTER X 2	PTO
3083577	340 F/C Injection	all	6206 C4	6007 PC4 x 2	6206 GPC4 x 6206 PC4
3084585	440-500 F/C	all	6206 PC4	6206 PC4 x 2	6206 GPC4 x 6206 PC4
3089483	440 XCF-550 F/C	98-13	5206 S9C4	6206 PC4 x 2	6207 GPC4 x 6207 PC4
	2-CYL L/C				
3084612	440-500L/C	86-95	6206 PC4	6206 PC4 x 2	6206 GPC4 x 6206 PC4
3084701	440 L/C XCR	94-95	6206 PC4	6206 PC4 x 2	6206 GPC4 x 6206 PC4
3085211	440 L/C XCR	96-97	6206 PC4	6206 PC4 x 2	62/32 PC4 x 62/32 GPC4
3085206	500 L/C	96-00	6206 PC4	6206 PC4 x 2	62/32 PC4 x 62/32 GPC4
3089530	500 L/C	00-10	5206 S9	6206 PC4 x 2	62/32 PC4 x 62/32 GPC4
2201865	440 L/C PRO X	98-03	6207 PC4	DG3572201C4	DG3572201C4 x 6207PC4
2202688	440 L/C PRO X	04-07	6207 PC4	DG3572201C4	DG3572201C4 x 6207PC4
2201234	500-600 L/C	98-03	6207 PC4	DG3572201C4	6207/9BA9T x 6207 PC4
2202520	500-600 L/C X	04-09	6207 PC4	DG3572201C4	6207/9BA9T x 6207 PC4
2201662	600-700 L/C	97-98	6207 PC4 x 2	6207 PC4 x 2	6207 GPC4 x 6207 9BA
2203320	600 HO, CF	07-13	6207 / 1BYA	DG3572201C4	6207/9BA9T x 2
2203803	600 IQ Racer	2008	6207 / 1BYA	DG3572201C4	6207/9BA9T, DG3572201C4
2203717	600 IQ Racer	09-14	6207 / 1BYA	DG3572201C4	6207 GPC4 X 5207SC4
2203578	600-700 LC IQ D	07-10	6207 / 1BYA	DG3572201C4	6207/9BA9T X 2
2201361	600-700 L/C HD	99-05	6207 PC4 x 2	6207 GPC4 x 2	5207 S9C4 x 6207 PC4
2203110	700 L/C Fusion	06	6207 / 1BYA	6207 GPC4 x 2	5208C4 x 2
2202443	700 L/C Front. 4-t	02-04			6207/9BA9T x 6207 GPC4
2201554	800 L/C Heavy	00-05	6207 PC4 x 2	6207 GPC4 x 2	5207 S9C4 x 6207 PC4
2203717	800 L/C Dragon,	08-13	6207 / 1BYA	DG3572201C4	5207 S9C4 x 6207 PC4
2203110	900 L/C	05-06	6207 / 1BYA	6207 GPC4 x 2	5208C4 x 2
	3- CYL L/C				
3084596	580 L/C mono	92-94	6206 PC4	6206 PC4 x 4	6206 GPC4 x 6206 PC4
3084679	600 L/C mono	95-96	5206 S9	6206 PC4 x 4	6206 GPC4 x 6206 PC4
3085437	600 L/C oil jet	97-00	5206 S9	6206 PC4 x 4	6206 GPC4 x 5206S9
3085250	600 SP-680 L/C	96	35BG06 S9	6007 PC4 x 4	6207 GPC4 x 6207 PC4
3084377	650 L/C CARB-	85-98	5206-S9	6206 PC4 x 4	6206 GPC4 x 5206S9
3085450	600-680-700	97-98	35BG06 S9	6007 PC4 x 4	6207 PC4 x 6207 GPC4
3085312	750-800 L/C	93-98	6207 PC4 x 2	6207 PC4 x 4	6307 GPC4 x 6307 PC4
3086127	700-800 XCR	99-03	35BG06 S9	6007 PC4 x 4	6207 GPC4 x 6207 PC4

Part number Dimensions

Part number 35-	Dimensions		5206 S9	30 X 62 X 23,8
6206 C4	30 X 62 X 16		5207 / 1BYA	35 X 72 X 36,5
6206 PC4	30 X 62 X 16		5207 S9C4	35 X 72 X 27
6206 GPC4	30 X 62 X 16		5208 C4	40 X 80 X 30,2
6207 PC4	35 X 72 X 17		62/32 GPC4	32 X 65 X 17
6207 GPC4	35 X 72 X 17		35BG06 S9	35 X 62 X 23,8
6207/9BA9T	35 X 72 X 24		DG3572201C4	35 X 78 X 20
6307 PC4	35 X 80 X 21		6307 GPC4	35 X 80 X 21

Part number Dimensions

Arctic Cat

Kurbelwellenlager

Crank	2-CYL F/C	Years	MGT	CENTER	PTO
3003275	340 F/C inj	87-94	83350A (DG2555	83350A (DG2555)	83519D x 83519D
3006941	370 F/C	99-08	83519D	83519D x 83519D	83519D x 83519D
3005921	440 F/C	97-06	83519D	83519D x 83519D	83519D x 83519D
3006098	440 F/C	02-06	83519D	83519D x 83519D	OE 3006-096 x 2
3003401	500 F/C	all	83519D x 83519D	83519D x 83519D	83519D x 83519D
3006005	570 F/C	02-09	6306N9C4 /	6306N9C4 x 2	35NQ5528W11
3007864	570 F/C	10-14	6306N9C4	6306N9C4 x 2	35NQ5528W11
	2-CYL L/C				
3004461	440 L/C	91-99	83519D	83519D x 83519D	OEM N/A
3003213	440 L/C	85-89	83519D x 83519D	83A073B x 83A073B	83A0729 x 2
3003832	440 L/C ZR	91-95	6306N9C4	83A073B x 83A073B	40NQ 6430W1
3005258	440 L/C ZR	96-98	6306N9C4	83A073B x 83A073B	40NQ 6430W1
3006624	440L/C	03-04	306/1DYR1W	83B551A 30mm x 2	40NQ 6430W1S
3006428	F-5	03-06	306/1DYR1W	83B551A 30mm x 2	40NQ 6430W1S
3007613	F-5	06-09	306/1DYR1W	83B551A 30mm x 2	40NQ 6430W1S
3005414	5-600ZR T-	98-03	83A073-9	83A073B x 83A073B	40NQ 6430W1
3003841	530 L/C	86-87	83519D	83A073B x 83A073B	OEM N/A
3003931	550 L/C	90-92	83A073-9	83A073A x 83A073B	40NQ 6430W1
3005230	550-580 L/C	93-05	83A073-9	83A073A x 83A073B	40NQ 6430W1
3005602	600 ZR	00-04	6306/4DYR1	83B551A 30mm x 2	40NQ 6430W1
	600 Sno Pro	04-	22075/1DYR1W	83B551A 35mm x 2	40NQ 6430W1S
3003894	650 L/C W-C	88-90	83B551A 35mm	83B551A 35mm x 2	OEM N/A
3004144	700 L/C EFI	93	83B551A 35mm	83B551A 35mm x 2	40NQ 6430W1
3004391	700 L/C	94-01	83B551A 35mm	83B551A 35mm x 2	40NQ 6430W1
3006710	F6-F7	03-06	22075/1DYR1W	83B551A 35mm x 2	40NQ 6430W1S
3006718	600-700 L/C	03-10	22075/1DYR1W	83B551A 35mm x 2	40NQ 6430W1S
3006053	800-900	02-08	307/1DYR1W10	6307R/1DYR x 2	3208/1DW11CA
	800 L/C	07-12	22075/1DYR1W	83B551A 35mm x 2	40NQ 6430W1S
3006918	900 L/C	03-05	307/1DYR1W10	6307R/1DYR x 2	3208/1DW11CA
3007260	1000 L/C	07-11	308YR1W10C = 37 x 90 x 23	DG379021NSL x 2 = 37 x 90 x 21	3209W11C4 = 45 x 85 x 30,2
	3-CYL L/C				
	600 L/C ZRT	95-02	83A073B	6207R9x2, 83A073Bx2	40NQ 6430W1
3004929	800-900 L/C	93-00	6306/4DYRI	6209/1DRIN X 4	6209/1DRIN X 2
3005640	1000 L/C	98-02	6306/4DYRI	6209/1DRIN X 4	6209/1DRIN X 2

Part number	Dimensions		Part number	Dimensions	
	Part number 35-	Dimensions		Parts number 35-	Dimensions
	22075/1DYR1W	35 X 75 X 23		DG2555	25 X 55 X 15
	3208/1DW11CA	40 X 83 X 30		35NQ5528W11	35 X 55 X 28
	306/1DYR1W	30 X 75 X 19		40NQ6430WI	40 X 64 X 30
	307/1DYR1W10	35 X 83 X 21		40NQ6430W1S	40 X 64 X 30
	6209/1DRIN	45 X 90 X 19		83519D	30 X 65 X 16
	6207R9	35 X 72 X 17		83A073-9	30 X 72 X 19
	6306/4DYR1	30 X 72 X 19		83350A	25 X 55 X 15
	6306/N9C4	30 X 72 X 19		83B551A 30 mm	30 X 75 X 17
6307R/1DYR	35 X 83 X 21	25 83B551A 35 mm	35 X 75 X 17		

Lager

Nummer	Bohr	o dia	Breite
35-6201	12	32	10
35-6202	15	35	11
35-620258	15,875	35	11
35-6203	17	40	12
35-6204N	20	47	14
35-6205N	25	52	15
35-6303	17	47	14
35-6304	20	52	15



Nummer	Bohr	o dia	Breite
35-CB205	25	52	15
35-SC205T	25,4	52	15



Nummer	Bohr	o dia	Breite
35-UC205	25	52	17
35-UC205T	25,4	52	17



Nummer	Bohr	o dia	Breite
35-30303			
35-3205	25	52	21



Nummer	Bohr	o dia	Breite
35-6004	20	42	12
35-6005	25	47	12
35-6006	30	55	12
35-6008	40	68	15
35-6010	50	80	16
35-6022	22	44	12
35-6228	28	58	16

Nummer	Bohr	o dia	Breite
35-SA205T	25,4	52	15



Nummer	Bohr	o dia	Breite
35-SB205	25	52	15
35-SB205T	25,4	52	15



Nummer	Bohr	o dia	Breite
35-RB205	25	52	15
35-AS205	25	52	15



Rod Ende

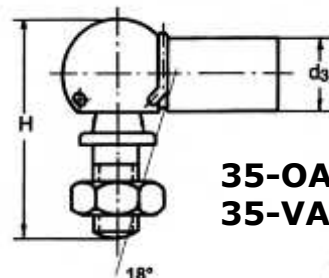

35-OAS16 M10 rechts
35-VAS16 M10 links



Schneemobil Kolben: Taiwan

- super Qualität, Ringe, Kolbenbolzen
- mos 2 surface

- 09-650 Bearcat 570
- 09-657 F7 Firecat
- 09-776 Rotax 600 H.O, E-Tec
- 09-778 Rotax 800 H.O.

Arctic Cat	Bore	Engine	Gasket set	Oil seals	Needle	Wössner
09-602	72,00	794 3-syl	710-193	09-55182	35-523	09-7012
Pantera 800 1998-01 ZRT 800 1995-01						
09-657	79,70	698 2-syl	710-275	09-55221	35-503	09-7009
Crossfire 7 -06, F7 Firecat 2003-06, Sabercat 2004-06, M72005-06						
09-682	81,00	699 2-syl	710-180; -91-96; 710-267; -97-01	09-55173	35-523	09-7010 09-7010-050
Wildcat 700 MC. EFI 1991-96, ZR 700 1995, ZL 700 2000, ZR 700 1999-00						
09-684	78,00	650 2-syl	710-180	09-55175	35-523	
Wildcat 650 1988-90, Mountain Cat 1990						
09-601	66,50	594 3-syl	710-216	09-55176	35-503	09-7006
EXT 600 Tr. 97-98 EXT 600 Triple Touring 1998 Powder EXT 600 1997-98 ZRT 600 1995-98						
09-681	75,40	580 2-syl	710-189	09-55176	35-523	09-7037
EXT 580 MC; EXT 580 EFI MC 1993-97; 580 Powder SP 1995-97; ZR 580 1993-97; Pantera 580 1995-97						
09-650	73,75	565 F/C 2-syl	710-270	09-55212	35-503	
Bearcat 570 2004-09, F570 08-, Mountain Cat 570 2002-, T570 2008-, Z570, LX, Panther 570 2002						
09-683, 687	73,40	550 2-syl	710-189	09-55176	35-523	09-7005
EXT special 1991-92 ; Pantera 550 2002-05, Panther 550 2000-01, ZL 550 ESR 2000-03; Bear Cat 550WT 2000-						
09-679, 605	71,00	497 2-syl	710-227; -98-01; 710-266	09-55203	35-523	
ZL 500 EFI 1998-01; ZR 500, ERSI 1998-01; Powder SP 500 EFI 1999-01						
09-699	72,00	529 2-syl	710-063D	09-55112	35-503	
Cheetah LC 1986-89; El Tigre 6000 1986-89; El Tigre EXT 1989-91; El Tigre Ext Mountain Cat 1990						
09-691	70,00	500 2-syl	710-063E	09-55109	35-503	
Cheetah FC, Cougar 1986-90						
09-693	70,00	500 2-syl	710-063	09-55109	35-503	
Panther 1986-88; Pantera el. 1980; Manx 2000S 1977-80, El Tigre 6000 LC 1980-85; El Tigre 5000 1977-81						
09-694	70,00	500 L/C 2-syl	710-063C	09-55112	35-503	
El Tigre 6000 LC 1980-85						
09-689	68,00	440 2-syl			35-522	
El Tigre 440 Z 1975-77; Kawasaki Intriguer, Intruder, Invader; Drifter 440 1978-81						
09-695	68,00	440 2-syl	710-063A	09-55112	35-503	
Panther 440 LC 96; ZL 440 1997-99; Prowler 1990-94; Jag 440 LC; El Tigre 6000 LC 1978-79; Jag 4000 FC 80-81						
09-696	65,00	431 2-syl	Tarkista netti	09-55109	09-502	
Bearcat 440 95-01; Cheetah 440 -94; Panther 4000 FC 80-81; Trail Cat 4000 FC 80-81; Jag 4000 FC 1980-81						
Jag 440 Z 91-96; Panther DeLuxe 440 84-01; Z 440 ES 90-01; Super Jag 91-92; Jag 440 DeLuxe 88-99; Jag AFS						
09-685	60,00	339 2-syl	710-032	09-55113	35-525	
Panther, Puma, Cheetah, Pantera 1971-1975 Lynx II -74Jag 340 -75						
09-692	60,00	339 2-syl	710-063B	09-55110	35-502	
Bearcat 340 -95-01; Cheetah 340 -94; Jag 340 76-77, 87-90; Jag 3000 FA, FC 78-80; Jag Deluxe 1987-90						
Trail Cat 3000 FC 1980; Manx, Manx Deluxe 1991-93; Manx Mountain Cat 1992-93; Puma DeLuxe 1994-97						

Rotax	Bore	Engine	Gasket set	Oil seals	Needle	Wössner	
09-778	82,00	793 HO, SDI	710-302	09-55229	35-507	09-7022	
Ski-doo, Lynx 800 HO, SDI makes 2000-2007							
09-782	70,50	809 3-syl	710-221 1997-2003	09-55181	35-503		
Formula 700, Legend 700, MXZ 700 Summit 700 2000-2002							
09-780	69,50	779 3-syl	710-222 3-syl	09-55181	35-503	09-7045	
09-780-02	70,00	500 2 syl	710-212 2-syl	09-55190	35-503	09-7045-050	
MM: Mach Z 780 1993-97; MXZ 500 98-Scandic WT LC 1999-00; Summit 500 1996-99;						09-7045-100	
09-783	78,00	700 2-syl	710-255	09-55217	35-507	09-7049	
Formula 700, Legend 700, MXZ 700 Summit 700, 2000-02, Enduro 700 2001-02, Enduro 700 RER 2002							
09-781	70,00	699 3-syl	710-222	09-55181	35-503		
Rotax 700; F 3 700 1998-00; GT 700 1998-00; GT SE 1997-98; Mach 1 700 1997-00							
09-773	78,00	669 2-syl	710-197 1993-94	09-55105	35-524	09-7056	
09-773-01			710-293 1995-95	09-55190	35-524		
09-773-02			710-215 1996-00	09-55190	35-524	09-7056-050	
09-773-04						09-7056-100	
Rotax 670; Mach 1 X 1993; Mach 1 1993-96; MXZ 670 1996-99; GT SE 1994-96;							
09-776	72,00	600 E-Tek, Sdi	710-303	09-55230	35-507	09-7021	
Rotax 600 HO RER, 600 E-Tec, 600 SDI							
09-785	76,00	597 2-syl	710-259	09-55205 -02	35-507	09-7047	
09-785-02				09-55215 03-		09-7047-050	
MM: Lynx 600 L/C; Formula 600 1999-01; MXZ 600 1999-02; Scandik 600 WT L/C 01-02						09-7047-100	
09-774	64,50	600 3-syl	710-213	09-55181	35-524		
Formula III 600 1995-97							
09-772	76,00	582 2-syl	710-178B 1988-92	09-55105	35-505		
09-772-01		582 2-syl	710-194 1993-96	09-55105			
09-772-02		583 2-syl	710-178C 1993-96	09-55105			
09-772-04		583 2-syl	710-214 1997-99	09-55105			
		617 2-syl	710-178B Mach 1	09-55105	35-505		
MM: Formula Plus, E, XTC,X 1992-93; F Plus EFI 1993-94; Summit 1994-96; Lynx makes 582-583 engine							
09-762 vas	76,00	635 2-syl	710-022X	09-55125	35-505		
09-762-02							
09-762-04							
09-763 oik	76,00	635 2-syl	710-022X	09-55125	35-505		
09-763-02							
09-763-04							
Alpine 640 1969-82; Nordic 640 1970-74; TNT 640 1971-72; Valmont 1971-72							
09-779	76,00	550 F/C	710-277	09-55215	35-524	09-7046	
09-779-01							
09-779-02						09-7046-050	
09-779-04		Rotax 550 F/C all					09-7046-100
09-761	69,50	436 2-syl	710-025 1971-76	09-55128	35-505		
09-761-01		467 2-syl	710-165C 1990-91	09-55105	35-505		
09-761-02		467 2-syl	710-165E 1992-93	09-55105	35-505		
09-761-04		467 2-syl	710-203 1994-95	09-55105	35-505		
MM.Rotax 444, 467; Elite 450 LC 1978-79; Everest 444 LC 1978-79; Everest 464 LC 1980-83; SS-25 1984							
09-740	69,00	247 F/C 1-syl		09-118	35-505		
09-740-02, -04		250 F/C 1-syl			35-505		
Spirit 250 1979-83; Elan 250 1979-96; Spirit 250 1976-78; Elan 250 E 1971-78							

Skidoo, Lynx	Bore	Engine	Gasket set	Oil seals	Needle
09-741	72,00	503 F/C	710-162 1979-90	09-55103	35-505
09-741-01			710-162 1991-94	09-55104	
09-741-02			710-196 1995-03	09-55104	
09-741-04		532 L/C	710-169	09-55103	
09-741-06		537 L/C	710-177 1989-91	09-55105	
Rotax 503,521,536 Lynx, Nordik, Ockelbo, Ski-doo, Trapper, Winha,					
09-741	72,00	253 F/C	710-164 1985-	09-55102	35-505
		277 F/C	710-195 1993-2009	09-55154	35-505
Lynx 250, Citation, Tundra, Tundra II, Freestyle, Scandik Tundra, GL 2300,					
09-752	67,50	447 F/C	710-162C 1984-90	09-55103	35-505
09-752-01			710-162C 1990-91	09-55104	35-505
09-752-02			710-210 1996-07	09-55104	35-505
09-752-04					
Forest Fox; Ockelbo, Ski-doo, Trapper, Scandic 440 LT 2001-07, MXZ 440 1999-01, TOUR. E 1999-					
09-751	62,00	377 F/C	710-023A 1980-89	09-55103	35-505
09-751-01			710-023C 1990-94	09-55104	
09-751-02			710-210 1995-2006	09-55104	
09-751-04					
09-751-06					
Rotax 377 ; Lynx, Nordik, Ockelbo, Ski-doo, Trapper, Winha					
09-760	67,50	436,6 F/C	710-163C	09-55101	35-505
09-760-01					
09-760-02					
09-760-04					
Blizzard 9500 1979-82; Ultra Sonic 1980-82					
09-759 right	67,50	436,6 F/C	710-025	09-55128	
09-759-02					
09-758 left	67,50				
09-758-02		436,6 F/C			
Everest 440 FC 1974-79; TNT 440 FC 1975-78; Olympic 1977; Futura 440 1975-79; Nuvik 440 1977					
09-750	59,50	339 F/C	N/A	09-165, 09-167	35-505
Blizzard 6500 Plus, 7500 Plus, Cross Country 1978-81; Super Sonic 1979-81					
09-748	59,50	339 F/C 2-syl	N/A	09-167	35-505
09-748-02					
09-748-04					
09-747	59,59	339 F/C 2-syl	N/A	09-167	35-505
09-747-02					
09-747-04					
TNT 340, 1972-76; Olympic 340, E 1975-79; Everest 340, E 1977-79; Futura 340 1975; Nuvik 340, E 76-79					
09-746	78,00	335 F/C 1-syl	N/A	09-118	35-505
09-746-02					
Olympic 335 1969-72; Skandic 1970-73					
09-745	54,00	247 F/C 2-syl	710-119	09-118	35-514
09-745-02					
Elan 250 1973-79					
09-742	76,00	319 F/C 1-syl	N/A	09-118	35-505
09-742-02					
Olympic 320, 320E 1969; Olympic 300, S, M, 1971-77					

Polaris	Bore	Engine	Gasket set	Oil seals	Needle	Wössner
09-730	85,00	800 2-syl	710-252	09-55193	35-526	09-7019
Indy 800 XC SP 2001-05, 800 SKS 2003, 800 Classic 2004, 800 LE 2001, 800 Pro X 2003-04, 800 Edge 04						
09-718	66,50	679 3-syl	710-206	09-55186	35-503	
Indy Ultra SP, Ultra SPX, SE, Ultra Touring 1996-97						
09-719	72,00	794 3-syl	Internet	09-55177	35-503	
Indy Storm 800 1994-98						
09-728	77,25	600 2-syl	710-251	09-55194		09-7017
Indy 600 Classic, Touring 2001, Indy 600 Touring 2000, 600 XC SP, Edge 2000, 600 XC SP 2001						
09-716	65,00	567 3-syl	710-204 1994-96	09-55107		
09-716-01			710-205 1997-			
09-716-02						
Indy XLT 600 1995-98; XLT SP 1997-98; Indy XCR 600 1995-97; XC 600 1997						
09-713	67,75	648 3-syl	710-181A			
09-713-01			Indy, Indy SKS	09-55107 88-92		
09-713-02			Indy RXL, SKS, EFI	09-55108 90-97		
09-713-04						
Indy 650, SKS 1988-93; Indy 650, RXL, SKS, 1990-97						
09-714	64,00	580 3-syl	710-191 1992-94	09-55107	35-525	
09-714-01			710-204 1994			
09-714-02						
09-714-04						
Indy 580 XLT, SKS, XLT SP 1993-94						
09-707	65,00	398 2-syl	710-109C	09-55107		
09-707-02		597 3-syl	710-175			
09-707-04						
Indy 400 1984-1991; Indy 600 1984-87						
09-720	70,50	500 2-syl	710-237 1999-01	09-55194	35-507	
09-720-02			710-250 2002-			
RMK 500, SKS 2000-02, 500 XC1999-02, Indy500 99, Indy 500 XC SP 1999-07, Indy 500 2001						
09-727	73,00	550 F/C	710-238 1998-2003	09-55196	35-503	09-7015
09-727-01			710-286 1994-	09-55218		
09-727-02						
09-727-04						
Indy 550 Classic, Sport Touring, Supersport 1999-2006, Pro X Fan, Kaikki 550 cc mallit						
09-711	72,00	488 L/C	710-185A 1989-95	09-55107	35-503	Kxxx00
09-711-01			710-208 1996-99	09-55107		Kxxx01
09-711-02		(500) L/C	710-253 2000-2012	09-55187		Kxxx02
09-711-04						Kxxx04
Indy 500 LC, Classic 1989-00; Indy 500, SKS, SP, 1990-98; Indy 500 EFI 1992-98; Widetrack 1997-2012						
09-712	72,00	488 F/C	710-109C	09-55107	35-503	
Indy Trail FC 1986; Super Sport 1997-98; Supertrac 1991-93; Indy Trail, Touring 1994-99						
09-710	67,75	440 2-syl	710-186	09-55107	35-503	
09-710-02						
09-710-04						
Indy Sport 1991-98; Sport GT 1991-93; Sport Touring 1995-98; Super Sport 1995-96; Transport 1996-98						
09-715	67,72	440 2-syl	Tarkista netti	Tarkista netti	35-505	
09-715-01						
09-715-02						
Indy Lite, DeLuxe; Indy Lite Gt 1994-98; Indy Lite Touring 1998						

Polaris	Bore	Engine	Gasket set	Oil seals	Needle
09-717	62,30	340 2-syl	710-173	09-55107	35-525
09-717-01					
09-717-02					
09-717-04					
Indy Lite, DeLuxe; Indy Lite Gt 1994-98; Indy Lite Touring 1998					
09-709	62,25	339 2-syl	710-173	09-55107	35-525
09-709-01					
09-709-02					
09-709-04					
Sprint ES 1986-90; Indy Sport, GT 1987-90; Indy Lite, GT, Starlite 1991-93					
09-708	61,78	333 2-syl	710-073	09-55107	35-513
09-708-02					
Colt SS 340 1977; Cobra 340 1978-79; SS 340 1979; Apollo, Galaxy, Cutlass 340 1979-1981					
09-706-02	62,50	336 2-syl	710-075A	09-55130	35-513
Starfire 340. 1976, TX 340 F/A 1973-82					
09-705	67,75	440 2-syl	710-079	09-140 x 2	35-520
TX 440 1976-80					
09-704	67,72	432 2-syl	710-078	09-55107	35-520
09-704-02					
TX-C 440C 1981; Long Track 1983-86; Sport, Super Sport SS 1983; TX 440 1973; Cobra 440 1978-79;					
09-703	53,40	250 1-syl	710-069	09-55130	35-520
Starfire 250 1976; TX 250 1976-79					
09-702	53,50	250 1-syl	710-069	09-55130	35-520
Colt 250 1976-78					
09-700	72,00	244 1-syl	710-069	09-55130	35-520
09-700-02		488 2-syl		09-55107	35-520
Electra 250 1975-77; Gemini 244 1979-83; Star 1983-90; Startrak 1987-90; Starlite Gt 1991-95					
Kohler					
09-670-02	62,50	340 2-syl		09-104, 09-113	35-513
09-670-04					
Lynx, Winha mm					
Sachs					
09-SM127	67,40	440 2-syl		09-116, 09-127	
Lynx , Winha mm					
09-801	72,96	290 1-syl			
09-801-01		Huom. mäntä on n. 1 mm matalampi ja helmat n. 2 mm lyhemmät			
09-801-02		Note: piston 1 mm lower, shirt 2 mm shorter, ok to use			
09-801-04					
Lynx, Ockelbo, Winha					
Kawasaki					
09-689	68,00	440 2-syl		09-14603 x 2	35-522
Kawasaki 440 Kawasaki Intriguer, Intruder, Invader; Drifter 440 1978-81					
09-685	60,00	339 2-syl		09-14603 x 2	35-525
Invader 340 F/C 1978-80, Inviter 340 F/C 1978, Drifter F/C 1979-81					

Rotax 503-253

10-741-00
10-741-01
10-741-02
10-741-04

Kolbenringe

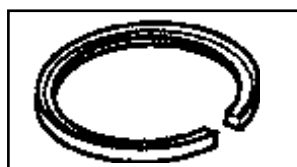

31

Rotax 377

10-751-00
10-751-01
10-751-02
10-751-04

Bolzen

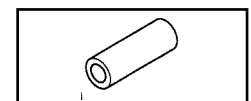











11-741
11-751

Yamaha	Bore	Engine	Gasket set	Stefat	Needle	Wössner
09-826	74,80	598 2-syl	710-201	09-55188	35-521	09-7025
09-826-02						
V-Max 600, LE, DX, ST, 1994-96						
09-817	73,00	569 2-syl	710-171	09-55170	35-521	
09-817-02						
09-817-04						
Exciter 570, 1987-90 Exciter 2, 1991-92						
09-816	73,00	535 2-syl	710-140A	09-55169	35-521	
VMX 540 1983-91						
09-808	73,00	535 2-syl	710-167 1979-90	09-55133	35-521	09-7058
09-808-01			710-182 VK540 1988-2005; 09-55133		35-521	
09-808-02						09-7058-050
09-808-04						09-7058-100
EC 540 1979-84 SR 540 1980-91 XL 540 1985-90 VK 540 1988-00						
09-825	68,00	493 2-syl	710-200	09-55188	35-521	
V-Max 500 LE, DX, ST, 1994-96						
09-813	72,00	485 2-syl	Internet	Tarkista	35-505	09-7057-
09-813-01						
09-813-02						09-7057-050
09-813-04				500 1999-06		09-7057-100
PZ 480 84-98 480 ST 91-98 VT 480 91-97 VT 480 GT 93-99 VT 480 TF/X 93-00; Venture						
09-806	68,00	433 2-syl	710-146	09-55131	35-505	
09-806-01						
09-806-02						
09-806-04						
GP; TL, 433 1975 EX 440 1976-81 GP 440 1976-78 PR 440 1976-77 STX 1976-77						
09-807	66,00	440 2-syl	710-147C	09-55133	35-505	
09-807-02						
SS 440 1980-83						
09-814	68,00	433 2-syl		09-137, 09-143	35-505	
09-814-02						
09-814-04						
SR 433, GPX 433 1971-75						
09-815	60,00	338 2-syl		09-137, 09-143	35-505	
09-815-01						
09-815-02						
GPX 338 F/A 1974-75						
09-804	60,00	338 2-syl	710-141	09-137, 09-143	35-505	
09-804-02						
EX 340 1976-78 STX 340 1976-1977						
09-803	60,00	338 2-syl	710-100	09-55133	35-505	
09-803-04						
GP 338 1973 SL 338 1974 GS 338, 340 1976-1979						
09-802	60,00	337 2-cyl	710-142	09-131, 09-132	35-522	
09-802-01						
09-802-02						
09-802-04						
EC 340 1982-88 ET 340 1978-88 CS 340 1989-00						

Yamaha	Bore	Engine	Gasket set	Oil seals	Needle
09-800	70,00	246 1-syl	710-027	09-131, 09-132	35-505
09-800-01					
09-800-02					
Br 250 1982-94 Br 250T, TS 1985-00; BR 250 TS 1984-97					
09-801	72,96	246 1-syl	710-138	09-131, 09-132	35-505
09-801-01					
09-801-02					
09-801-04					
ET 250 1977-81					
09-812	73,00	292 1-syl			35-505
09-812-01					
GP 292 1972-73 SM 292 1973-74					
09-811	56,00	292 2-syl	710-138B	09-135, 09-143	35-505
09-811-02					
ET 300 1980-84					
09-810-02	73,50	292 1-syl			35-505
SL 292 1971-72					

Exhaust gaskets

718-059 Arctic Cat	718-024 Rotax	718-163 Rotax	718-178 Rotax
			
370,440,500,600	377, 447 F/C	503, 550 F/C	
718-185 Rotax	718-192 Rotax	718-071 Polaris	718-164 Polaris
			
600 L/C	500 L/C	340,440,448	600, 700 U.S.
718-186 Polaris	718-187 Polaris	718-190 Polaris	718-184 Polaris
			
440,544 F/C	500,660 U.S	440,700,800 U.S	440 L/C

08-100 Carburetor gasket Rotax



08-103 Mikuni repair kit



08-104 Mikuni repair kit, doble

Sekundär Variator

Jahre Year	Modell, modelle	Ro- tax	Nummer part #
	Terri 30, 2020		14-6038
	Trapper, Ockelbo		14-6024
1984-93	535, 5900 GLX, 650	503	14-6028
-93	GL 250	253	14-6028
-93	360, Ranger, GL3300	377	14-6028
1994-96	360 S, Ranger	377	14-6041
-96	Ranger 380, Fox, Light	380	N/A
1994-96	GLX 5900FC, 650 S	503	14-6041
1994-96	GLX 5900 LC	493	14-6041
1997-98	Ranger 380,	380	N/A
1997-98	Fox, S, Light Touring	380	N/A
1997-98	GLX 5900 FC, 6900	503	14-6032
1997-98	GLX 5900 LC	493	14-6032
1999-03	GLX 5900 FC	503	14-6032
1999-04	6900 Alpine III	503	14-6032
1999-??	Fox 440	447	N/A
1999-00	GLX 5900 Skandic 500	493	14-6032
2000-	Ranger 500 FC	503	14-6032
2000-	Ranger 500 LC	493	14-6032
2001-	5900 ST	593	14-6032
2004-	SUV 550, Ranger	550	14-6032
2004-	6900	550	14-6032
2004-	SUV 600, ST 600	593	14-6033
2004-	5900 Yeti V-1000 V800		14-0021
2005-	5900 Yeti 600 HO SDI	593	14-6021
2006-	SUV 600, Ranger 600	593	14-6021
2007-	TUV 600 HO SDI	593	14-6021
2007-	Yeti, Yeti Pro V-800	800	14-6021



Wenn die Welle 25,0 mm;
Keilnut 8 mm
Wenn die Welle 22,2 mm;
Keilnut 6mm
Aber 14-6038 ist 5 mm

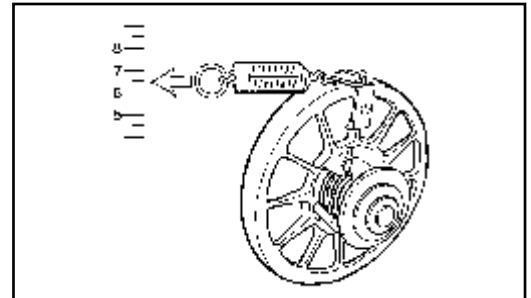

Einstellen
Bei einer neuen Kupplung oder bei Reparatur der alten, immer daran denken, das die Kupplung vorgespannt werden muss, sonst funktioniert die Kupplung nicht.
Nie Fett an den Varios verwenden.

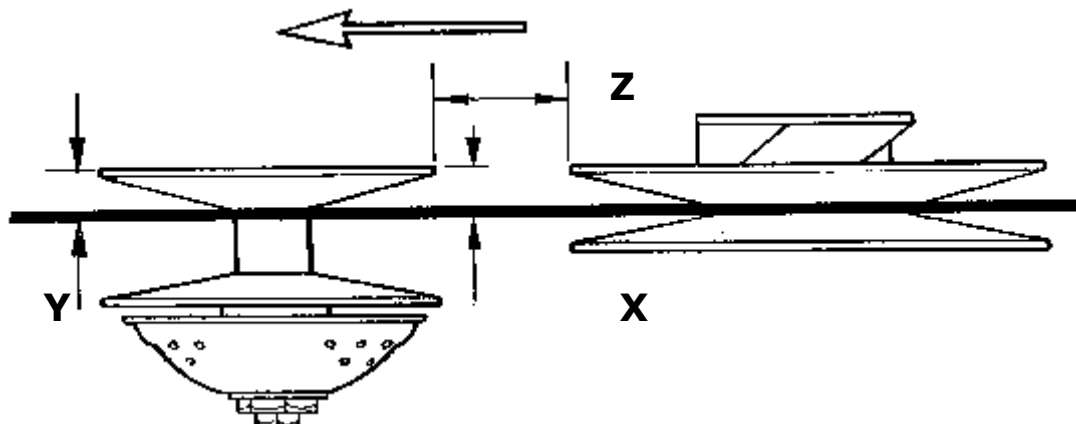

Powerline

Überprüfen Sie die Powerline mit 12 mm dicken Eisenstange. Wenn es keine Gummi stopfen Abstellen des Motors zu drehen, wenn mit dem Gas, dann Y muss 1,0 - 1,5 mm größer als X Beachten Sie auch, dass aufgrund der geringeren clutch, ändert sich der Abstand Z in Service-Handbuch nicht vorhanden . Es ist etwas anderes, aber der Unterschied ist akzeptabel.

Powerbloc 80



Wartungsfreie Kupplung jetzt für leistungsstarke flüssigkeitsgekühlte Motoren
 Diese Kupplung hat keine Arme, Hebel oder andere Teile, die beschädigt werden können.
 Sehr zuverlässig. Auf der Kupplung kann der ursprüngliche Anlasserzahnkranz montiert werden.

Kupplungen sind vorkalibriert,

Die Kupplung wird seit 2008 sehr erfolgreich verkauft.



Polaris

15-84	Alle Motoren 488 cc	1989-
15-84	600 cc 2-cyl Kleine Kegel	1997-
15-88	600 cc 2-cyl Groß Kegel	2007-
15-84	600 cc 3-cyl	1996
15-84	700 cc 2-cyl	1997-06
15-84	800 cc 2-cyl	2000-05
15-84	750 cc 4-stroke turbo	2006-
18-88	800 cc, big 32 mm Kegel	2008-



Arctic Cat



Kleine Kegel		
15-85	Alle weniger als 700 ccm Motoren	
Groß Kegel auf die folgenden Motoren aus 2003		
15-86	599 3D 2-cyl. 114 hp 31 mm	2003-
15-86	658 cdi 3-cyl. 110 hp Bearcat 660 Bearcat Z1 31 mm	2003-
15-86	698 3D 2-cyl. 140 hp 31 mm	2003-2006
15-83	1049 Yamaha engine	2014-
15-87	800cc-Motoren und Typ 8000	2007-2013
15-87	Die Kupplung mit speziellen Kappen	2014-

Skidoo & Lynx

p/n	Motoren,	Jahre,	beachten Sie,
15-81	Rotax 453	MXZ 440 LC X	
15-82	Rotax 593, 500SS	1999-2005	15-81 2006-
15-81	Rotax 693 2-cyl	1999-	
15-81	Rotax 699 3-cyl	1996-	
15-81	Rotax V-810	2007-	
15-81	Rotax V-1000 V800	2003-	
15-81	Rotax V-1200, 900 ACE	2009-	ACE 900 makes
15-82	Rotax 493, 494	1996-	
15-82	Rotax 593HO,600 SDI	2003-2005	15-81 2006-
15-81	Rotax 600 ACE, E-Tec	2009-	TRA fixing bolt
15-82	Rotax 670	1993-	
15-84	Rotax 582, 583, 643	1993-	no electric gear ring
15-81	Rotax 800HO, 800R	alle	
15-81	Rotax 800 E-Tec	alle	

Makes 15-81 and 15-82, big cone. Without gear ring both makes can be used. But 15-84, is small cone.

Yamaha

15-83	500, 494 cc	1994-2001
15-83	600 cc 2-cyl	1994-1999
15-83	600 cc 3-cyl	1999-2005
15-83	700 cc	1996-2005
15-83	499 cc 80 hp	2007-
15-83	973 cc 120 hp	2005-
15-83	998 cc Rx1	VK10 2003-
15-83	1049 cc Nytro Viper	2008-



P80 Federn

Number	CVTech	N min/ 72 mm	N max / 45 mm	Länge	A dia.	i
15-90	1151-1142	1000	1500			
15-91	0451-1135	900	1300	134,0	5,50	6,75
15-92	0451-1136	900	1600	109,0	6,00	6,00
15-93	1151-1132	810	1150	143,0	5,50	8,00
15-94	0451-1134	742	1612	95,0	6,00	5,00
15-95	1151-1109	300	1100	82,0	6,00	5,25
15-96	1151-1114	400	900	94,0	5,50	5,80
15-96A	1151-1116	400	1300			
15-96B	1151-1120	500	1100			
15-97	1151-1133	800	1300	121,0	5,50	
15-98	1151-1113	400	700	111,0	4,90	
15-99	0451-1128	700	900	164,0	5,00	8,25



P50 clutch

Nummer	S4B	P50 numero	CVTech	PTO	Belt	x	Use
15-02	5913B	0403-0002		2,50	31,7		15-02
15-03		0403-0003	15-0147C	8,77	34,8	8	15-03
15-04		0403-0004	15-0148C	8,77	34,8	8	15-04
15-05	0513B	0403-0005		11,5	33,3	6	15-05
15-06	8113B	0403-0006	15-0149C	6	34,9		15-06
15-09	9513B	0403-0009		11,5	34,9	6	15-04
15-10	9713B	0403-0010		5	33,3		15-10
15-11	9213B	0403-0011	15-0151C	1,5	34,9		15-11
15-18	9113B	0403-0018	laippa	4,99	34,9		15-18
15-22	3113B	0403-0022	laippa	0,06	32,7		15-22

X = Schraube für Zahnkranz, 6 mm oder 8 mm

P50 Federn

Nummer	CVTech	N min /	N max /	Length	A dia.	Note
		72 mm	45 mm	mm	mm	
15-52	0151-0002	618 / 637	1050 / 1115	110 / 108	5,26 / 5,50	+ 1
15-51	0151-0003	730 / 730	987 / 1056	158 / 132	4,88 / 5,50	+ 1
15-55	0151-0004	728 / 708	1110 / 1056	134 / 127	5,26 / 5,50	
15-53	0151-0006	500 / 499	1070 / 1142	095 / 93	5,71 / 6,00	
15-54	0451-1118	500 / 501	700 / 832	148 / 114	4,50 / 5,50	+ 1
15-55	0451-1129	700 / 708	1100 / 1056	123 / 127	5,26 / 5,50	
15-56	0451-1137	595 / 604	852 / 929	135 / 122	4,88 / 5,50	+ 1

Abzieher für P50, P80, TRA, Alt L = Länge

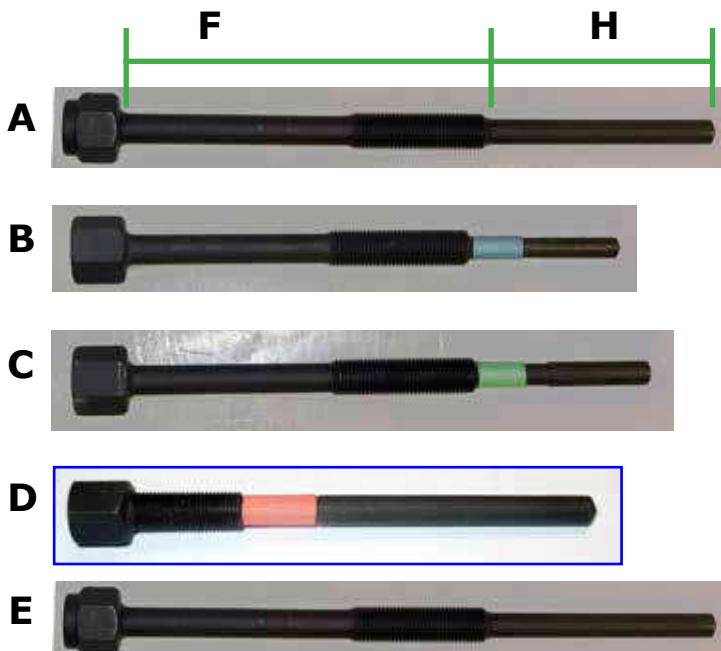

	P/N	F	H	L	Gewinde	alt
A	18-1066	135	93	248	M14-1,5	211
B	18-1067	127	63	210	M14-1,5	212
C	18-1065	127	73	220	M14-1,5	210
D	18-1064	39	128	187	9/16-18	209
E	18-1070	153	111	285	M14-1,5	223
X	18-0062	150	130	300	M14-1,5	-

	P/N	Fits..
A	18-1066	P80, Arctic Cat, 15-85, 15-86
B	18-1067	P80, Universal P50
C	18-1065	P80, Universal P50
D	18-1064	ALT clutches
E	18-1070	P80, Polaris 15-84, 15-88
X	18-0062	P80, Arctic Cat, 8000 makes

ALT-Kupplung



15-0513A

15-3913A

15-3113A

15-2913A

Kupplung	PTO typ	PTO	Belt	passend
15-0513A	Kegel 30 mm 1/10	- 2,0	33,3	Lynx, Skidoo
15-0613A	Gewinde 7/8" 14UNF		33,3	Alpine
15-0913A	Gewinde 7/8" 14UNF		31,7	Alpine
15-1013A	Gewinde 3/4" 14UNF		31,7	Elan
15-1213A	Cone 30 mm 1/10	- 6,35	31,7	Lynx, Skidoo
15-1713A	Gewinde M28x1" Cyl 24,6		31,7	Yamaha
15-2813A	Kegel 30 mm 1/10	+14,27	34,9	Polaris
15-2913A	Kegel 30 mm 1/10	- 12,7	31,7	Yamaha
15-3113A	Kegel 30 mm 1/10	- 12,7	31,7	Yamaha
15-3913A	Kegel 30 mm 1/10	- 12,7	33,3	Rotax 253
15-5013A	Cyl 1" Keilnut 1/4"		31,7	

Ersatzteile für ALT-Modelle



16-11



16-06



16-09



16-08



18-060
18-090



16-07



16-02

ALT Federn

T/N	CVTech	länge mm	Dia	min. Nm	max. Nm	i
19-12	X-5243212	70		108	1677	Terri
19-02	X-5243300	76,8	6,30	455	1852	6,00
19-01	X-5243302	78,5	6,30	526	1879	6,25
16-20	X-5218300	76,0	5,50	223	978	6,00
16-21	X-5218400	100,0	5,50	832	1535	6,25



**Schlüssel zu öffnen:
P50, P80, ATV-clutch
Teilenummer: 18-300**



**Abzieher für : p/n 18-209
thread: 9/16 -18**



S4B-Kupplung, Tundra II , 15- 9713B



18-130



18-030

S4B Ersatzteile



18-100



17-050



17-051



18-060
18-090



18-140
18-200



18-120



17-090



16-07



16-08



17-040 Cap

Driven pulley, Ersatzteile



14-16
cam



14-10
shim



Länge 39 mm
dia 38 mm
outer d. 44,5 mm

14-08
bearing



14-15
cam 14- model

P50 Ersatzteile



19-100



19-120



19-170 screw
19-171 polaris
19-140 shim
17-112 nut
18-160 washer



19-050



19-130



19-030



16-08



16-07

Trailbloc - ATV

Kalibrierte Kupplung für ATV,
Hersteller:

CVTech-IBC



Kalibrierte	cc	Jahre	Polaris
13-0042	350	90-93	350L, Trail Boss 350
13-0042	400	94-03	400L, Big Boss 6x6, Scrambler, Trail Blazer, Xplorer, Xpress
13-0042	400	11-13	Sport 400L 2x4, Sportsman 400 HO,
13-0043	425	95-98	Magnum 425 alle
13-0042	455	06-07	Sportsman 450
13-0012	500	04-05	ATP 500 HO 4x4, Sportsman 500 HO EBS, 500 DUSE
		98-09	Sportsman EFI EBS all, Sportsman 500 EN, Worker EBS
13-0040	500	98-09	Scrambler 500 alle
		01-12	Sportsman 500 HO, EFI
13-0043	500	98-08	Big Boss 6x6, (Magnum 500 4x4 -00)
			Sportsman 500 HO, 500 6x6,
13-0081	550	09-13	Sportsman XP 550 EFI
13-0009	600	03-05	Sportsman 600 Twin
13-0009	700	03-04	Sportsman 700 Twin EBS
13-0010	700	04-08	Sportsman MV7 EBS, Sportsman 700 EFI EBS
			Sportsman 700 EFI EBS
13-0011	800	05-07	Sportsman 800 EFI EBS
13-0047	800	07-12	Sportsman 800 EFI,
13-0082	850	09-14	Sportsman, Scrambler
			Can-Am
12-0066	400	02-	Outlander 400 HO
12-0033	500	08-	Outlander 500 HO, Renegade
12-0034	650	02-	Outlander 650 HO alle,
12-0067	800	06-	Outlander 800 HO, 800 R
12-0068	800	07-	Renegade 800 HO, 800 R
12-0075	1000	11-	Commander 1000
12-0085	1000	12-	Outlander/Renegade 1000
			Kawasaki
P50 clutch	400	97-02	Prairie 400
13-0007	650	02-12	Brute Force 4x4 alle
13-0007	700	04-09	Prairie 700 4x4 alle
13-0007	750	05-11	Brute Force 750 4x4 alle
			Honda
ALT clutch		alle	Pilot
			Suzuki
13-0007	700	alle	Twin Peaks 700 4x4
			Arctic Cat
13-0007	650	04-06	650 V-Twin 4 x 4 Automatic

RIPSAW FULL

Model
9002U



Model	Dimension cm	Lug h. mm	Weight kg
2,52"			
9002	50 x 396	32,0	31,0
9151	50 x 396	32,0	31,0

Model	Dimension cm	Lug h. mm	Weight kg
2,86"			
9089	50 x 391	35,0	30,0



ICE WIDE TRACK

Model
9008U



Model	Dimension cm	Lug h. mm	Weight kg
2,52"			
9008	50 x 396	32,0	33,0



NEW COBRA WT New COBRA WT600

Model
9195U



Model	Dimension cm	Lug h. mm	Weight kg
2,86"			
9195	50 x 392	46,0	29,0
9196	50 x 392	38,0	28,0

Model	Dimension cm	Lug h. mm	Weight kg
2,52"			
9260	60 x 396	46,0	36,0
9261	60 x 396	38,0	34,0

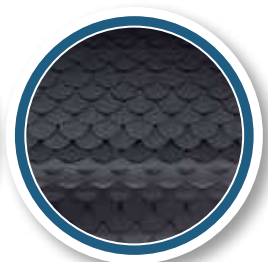

UTILITY

ENERGY

TRAILS

Model	Dimension	Lug h.	Weight
2,52"	cm	mm	kg
9793	38 x 307	25,0	15,0
9794	38 x 345	25,0	16,0

TRAILS

HACKSAW

Model	Dimension	Lug h.	Weight
2,52"	cm	mm	kg
9147	38 x 307	25,0	15,0



Model	Dimension	Lug h.	Weight
2,86"	cm	mm	kg
9190	38 x 307	31,0	18,0
9236	38 x 327	31,0	19,0

Model	Dimension	Lug h.	Weight
2,52"	cm	mm	kg
9033	36 x 307	38,0	17,0
9034	36 x 345	38,0	18,0
9044	36 x 365	38,0	19,0

OE Competition Track

Model	Dimension	Lug h.	Weight
2,86"	cm	mm	kg
3490	38 x 371	54,0	22,5



NEW ICE ATTACK XT



FREERIDE

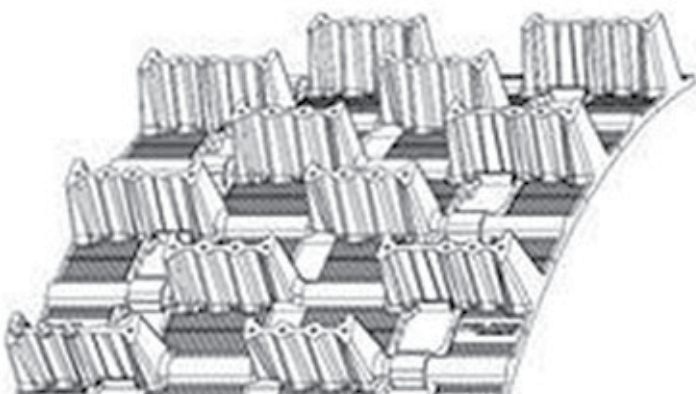

COBRA

TRAILS

Model
9052H



Model 2,52"	Dimension cm	Lug h. mm	Weight kg
9052	38 x 307	34,0	17,0
9081	38 x 325	34,0	18,0
9061	38 x 345	34,0	19,0
9107	38 x 366	34,0	20,0

Model 2,86"	Dimension cm	Lug h mm	Weight kg
9092	38 x 305	34,0	15,0
9235	38 x 327	34,0	16,0
9093	38 x 348	34,0	17,0
9120cw	38 x 371	34,0	18,0
9114	41 x 348	34,0	18,0

cw = center window

COBRA 1,6



Model 2,86"	Dimension cm	Lug h mm	Weight kg
9262	38 x 305	41,0	17,0
9263	38 x 327	41,0	18,0
9264	38 x 348	41,0	19,0
9283cw	38 x 392	41,0	21,2
9265	41 x 348	41,0	20,0
9282	41 x 392	41,0	22,8

ICE COBRA 1,6

Model 2,86"	Dimension cm	Lug h mm	Weight kg
9244	38 x 305	41,0	17,0
9245	38 x 327	41,0	18,0

ICE COBRA 1,6



NEW ICE Cobra 1.6

**Our Denis Courtemanche
Special Edition**

This recently launched Cobra track featuring ICE Technology has been named the "Denis Courtemanche Special Edition," in honor of the longtime Camoplast recreational products director and former Bombardier employee who has devoted 50 years to improving snowmobile track design.

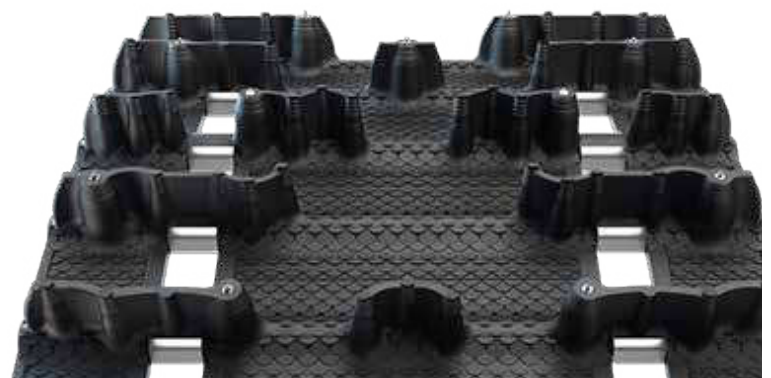

NEW RIPSAW II

Model
9156H



RIPSAW

Mallit
9968H144 &
9969H162
TRACKtion
Control™



RIPSAW 1.5

Model
9112C



Model 2,52"	Dimension cm	Lug h. mm	Weight kg
9214	38 x 307	32,0	19,0
9215	38 x 325	32,0	20,0
9216	38 x 345	32,0	21,0
9021	41 x 345	32,0	

Model 2,86"	Dimension cm	Lug h. mm	Weight kg
9210	38 x 305	25,0	15,0
9224	38 x 348	25,0	17,0
9156	38 x 305	32,0	16,0
9223	38 x 348	32,0	19,0
9237	38 x 327	32,0	18,0
9304	38 x 305	38,0	16,8
9305	38 x 327	38,0	17,9
9306	38 x 348	38,0	19,5

TRAILS

Model 2,52"	Dimension cm	Lug h. mm	Weight kg
9146	38 x 307	32,0	16,0
9040	38 x 325	32,0	19,0
9969	38 x 345	32,0	20,0

Model 2,86"	Dimension cm	Lug h. mm	Weight kg
9148	38 x 305	25,0	15,0
9149	38 x 305	32,0	16,0

Model 2,52"	Dimension cm	Lug h. mm	Weight kg
9045	34 x 325	38,0	18,0
9112	38 x 307	38,0	19,0

9045 track = Every 3rd / open windows

Model 2,86"	Dimension cm	Lug h. mm	Weight kg
9159	38 x 305	38,0	17,0
9238	38 x 327	38,0	18,0

SOKOSTI

Model 9003C



SOKOSTI

TRAILS

Model 2,52"	Dimension cm	Lug h. mm	Weight kg
9003	38 x 366	38,0	23,0
9004	38 x 384	38,0	24,0
9005	38 x 404	38,0	22,0

INTENSE

INTENSE



Model 2,52"	Dimension cm	Lug h. mm	Weight kg
9930	38 x 307	38,0	18,0
9108	38 x 345	38,0	19,0

FREERIDE

Model 9033C



SNO X

Models 9169R & 9189R



SNO X

RACING

Model 2,86"	Dimension cm	Lug h. mm	Weight kg
9169	38 x 305	44,0	18,0
9189	38 x 327	44,0	20,0



SNO X, New

Model 2,86"	Dimension cm	Lug h. mm	Weight kg
9293	38 x 305	44,0	18,0
9294	38 x 327	44,0	20,0

CHALLENGER TRAIL

CROSS-COUNTRY

Model
9069C



Model	Dimension cm	Lug h. mm	Weight kg
2,52"			
9933	41 x 345	44,0	22,0

Model	Dimension cm	Lug h. mm	Weight kg
2,86"			
9069	41 x 305	44,0	18,0
9070	41 x 348	44,0	20,0
9167	41 x 371	44,0	22,0

BACKCOUNTRY

Model
9140C



Model	Dimension cm	Lug h. mm	Weight kg
2,52"			
9140	38 x 307	44,0	18,0
9141	38 x 325	44,0	19,0
9142	38 x 345	44,0	20,0
9143	38 x 366	44,0	21,0

BACKCOUNTRY X

BACKCOUNTRY X

Model
9125C



Model	Dimension cm	Lug h. mm	Weight kg
2,86"			
9287	38 x 305	44,0	18,0
9126	38 x 348	44,0	20,0
9256	38 x 305	51,0	19,0
9257	38 x 327	51,0	20,0
9258	38 x 348	51,0	21,0

Model	Dimension cm	Lug h. mm	Weight kg
3,00"			
9254	38 x 358	44,0	23,0
9328	38 x 388	44,0	20,8

NXT GEN MTN Track

Pitch 3,00"
Pitch 3,50"

Camso Conquer 280

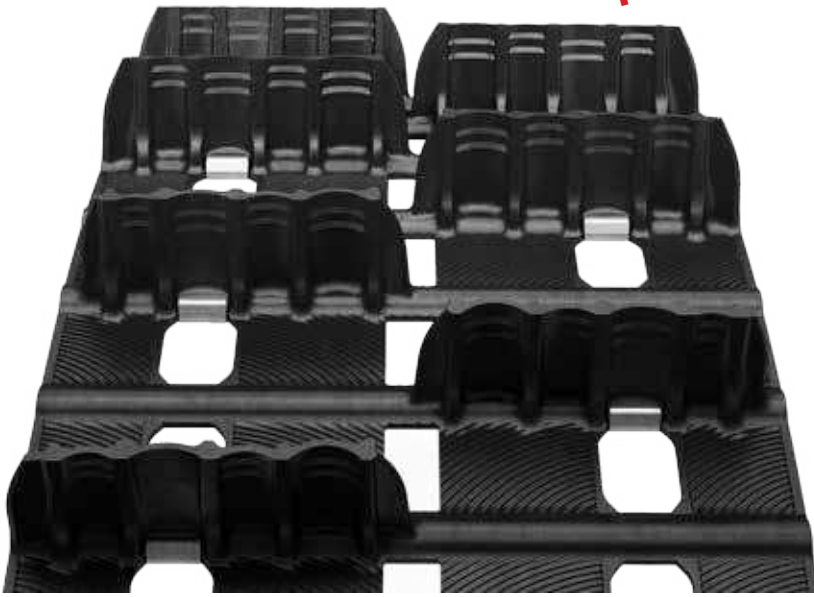

Model	Dim. cm	Lug mm	Weight kg
9337cw	38 x 388	71,1	19,5
9336cw	38 x 396	71,1	19,9
9335cw	38 x 411	71,1	20,9
9334cw	38 x 442	71,1	22,2
9340cw	38 x 419	71,1	20,4
9341cw	38 x 391	71,1	19,1

Additional lug edges for greater flex and improved traction in loose powder snows. Angled lug design to cup snow to improve forward traction and floatation. Calculated support columns to allow calculated cup and flex formation for unmatched floatation and lift of the vehicle. Provide Stiffness and support for wet heavy snow condition.



FEATURES

BENEFITS

- Lightweight – the NXT GEN MTN Track is the lightest MTN track in history and utilizes Camso leading edge track molding processes. Sizes available are lighter than any other track in comparable lengths – and even lighter than lower lug height models in similar/shorter lengths.
- New industry 1st 2.8" lug height. Vehicle fitment - clearance
- New optimized lug height for handling, agility and performance in all season riding conditions
- Go places where once only deeper lug tracks would go with less rider input needed
- With the new MTN track – riders have confidence to tackle the toughest technical tree riding, side-hill in the steepest terrains and reach new peaks in climbing. Rider input to initiate a turn or side hill is reduced by an excess of 20%. 25% less throttle is required to hold side hills or maneuver throughout difficult terrains.
- o Unmatched flotation and forward traction in all types of snow – flotation and traction of a 16-inch width track but the agility and handling of a 15-inch width product
- o Immediate lift, allowing snowmobile to stay on top of snow vs. trenching in soft, deep powder snow

CHALLENGER X 3,2

cw = center window

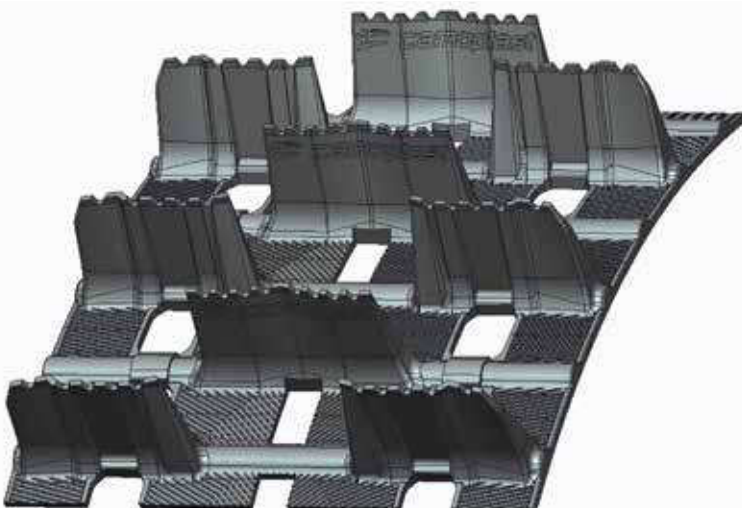

Model 3,00"	Dimension cm	Lug h mm	Weight kg
9319cw	38 x 411	81,3	24,4
9320cw	38 x 396	81,3	23,1
9321cw	38 x 388	81,3	22,6

CHALLENGER EXTREME

MOUNTAIN

Full Clip

Models
9104M &
9105M



Model 2,86"	Dimension cm	Lug h. mm	Weight kg
9102	41 x 391	64,0	27,0
9103	41 x 414	64,0	28,0
9104cw	38 x 391	64,0	25,0
9105cw	38 x 414	64,0	26,0
9144	41 x 371	64,0	25,0
9145cw	38 x 371	64,0	24,0

Model 3,00"	Dimension cm	Lug h. mm	Weight kg
9329	38 x 358	64,0	21,3
9035	38 x 442	64,0	29,0
9225	41 x 396	76,0	31,0
9951	38 x 381	76,0	30,0

cw = center window

Model 3,00"	Dimension cm	Lug h. mm	Weight kg
9174	38 x 389	64,0	26,0
9175	38 x 412	64,0	25,0
9176	41 x 412	64,0	26,0

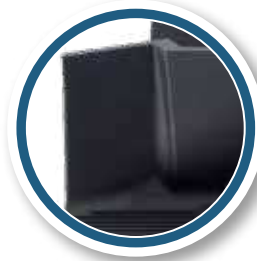

CHALLENGER

Full Clip

Models
9174M &
9175M



CHALLENGER 3 NEW

Full Clip

Model
9219M



Model 3,00"	Dimension cm	Lug h. mm	Weight kg
9219	41 x 412	76,0	28,0
9220cw	38 x 412	76,0	26,8
9309	38 x 396	76,0	25,8
9271	38 x 442	76,0	29,0



Models
9230 &



Model 2,86"	Dimension cm	Lug h mm	Weight kg
9182cw	38 x 371	64,0	24,4
9179	41 x 371	64,0	25,0
9230cw	38 x 392	64,0	25,0
9231cw	38 x 414	64,0	27,0
9232	41 x 392	64,0	27,0
9233	41 x 414	64,0	29,0

PEAK 2.5

cw = center window

MOUNTAIN

CHALLENGER

Model 2,52"	Dimension cm	Lug h. mm	Weight kg
9797	38 x 345	51,0	23,0
9798	38 x 307	51,0	20,0
9875	38 x 366	51,0	23,0
9876	38 x 384	51,0	24,0
9884	38 x 403	51,0	25,0
9941	41 x 403	57,0	
9899	41 x 365	51,0	21,0

Model 2,86"	Dimension cm	Lug h. mm	Weight kg
9064	41 x 371	59,0	22,0
9065	41 x 391	59,0	24,0
9186	41 x 348	51,0	23,0
9899	41 x 365	51,0	24,0
9187	41 x 371	51,0	22,0
9188	41 x 391	51,0	26,0
9204	41 x 348	59,0	21,0

Model
9064M



Rip Saw Profilen

Pitch. 2,52"

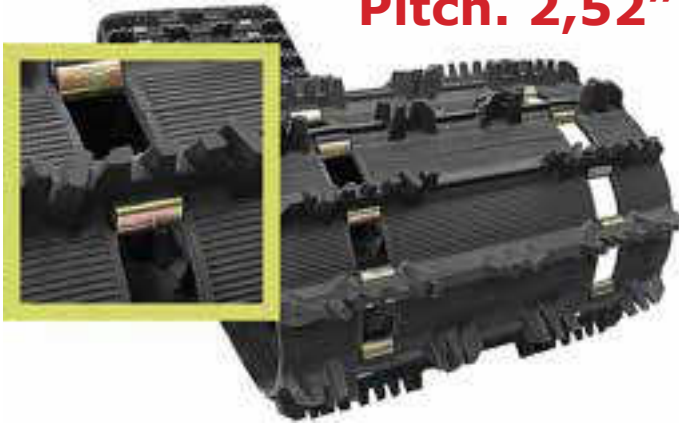

Rip Saw 32 mm			
Nummer	Breite	Länge	cam
	cm	cm	mm
04-9006	38	365	32
04-9007	38	385	32
04-9925	38	403	32
Sonderbreite, jeden 3., offenen			
04-9021	40,5	345	32



6900-track 31 mm full clip			
Nummer	Breite	Länge	cam
	cm	cm	mm
04-7000	60	397	31
Durasport 25 mm, full clip			
04-9863	38	345	25



Durasport 15 mm full clip			
Nummer	Breite	Länge	cam
	cm	cm	mm
04-9755	38	290	15
wheel suspension			
04-9756	38	290	15
slide suspension			



Explorer 25 mm Full clip			
Nummer	Breite	Länge	cam
	cm	cm	mm
04-9806	38	396	25

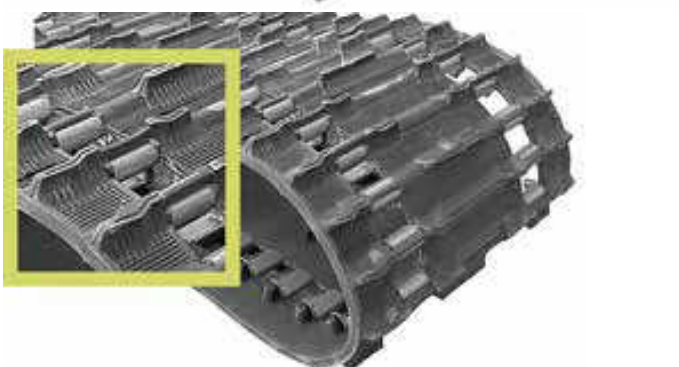

Explorer 19 mm full clip			
Nummer	Breite	Länge	cam
	cm	cm	mm
04-9011	38	353	19

Pitch. 1,97"

Snowmobile production at Camoplast facility located in Tampere, Finland is being transferred and phased out. Snowmobile production for current production snowmobiles is being transferred to Plattsburgh, NY USA. For snowmobile tracks produced from flat press tooling for aftermarket service parts, production will be phased out.

Lynx 5900 how to replace a new model track

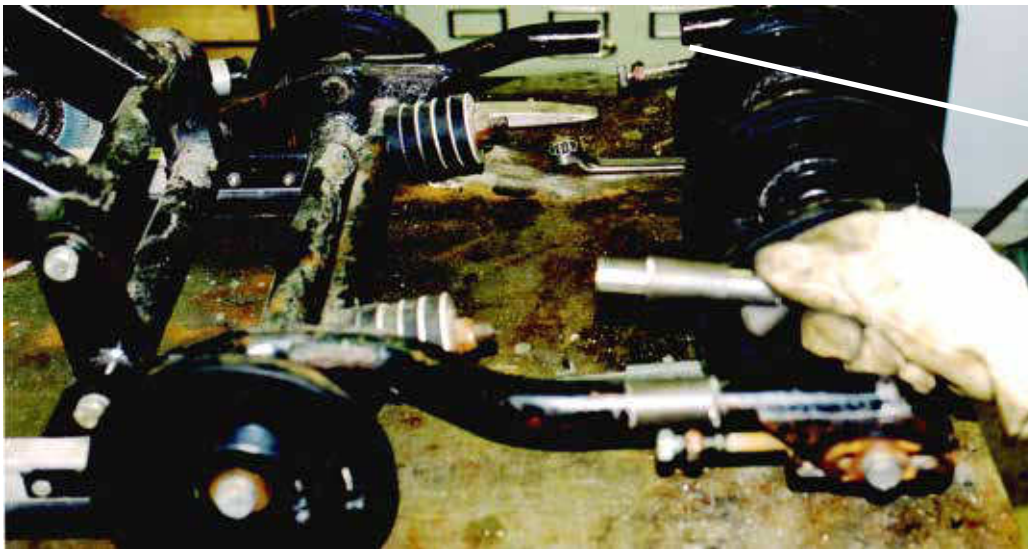

Cut the tubes

Weld the piece of tube between the tubes you cut.

The pieces are delivered with the track.

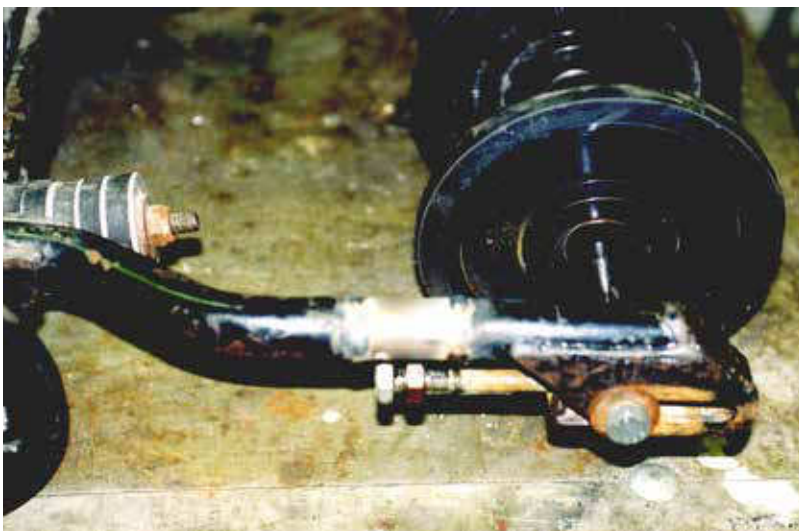

The weld has been done
This snowmobile has round rear wheels. You can replace also rear sprockets, if they exist.

You must replace also drive sprocket. It is only possible if there is a hexa drive shaft.

We prefer to use No Slip wheels

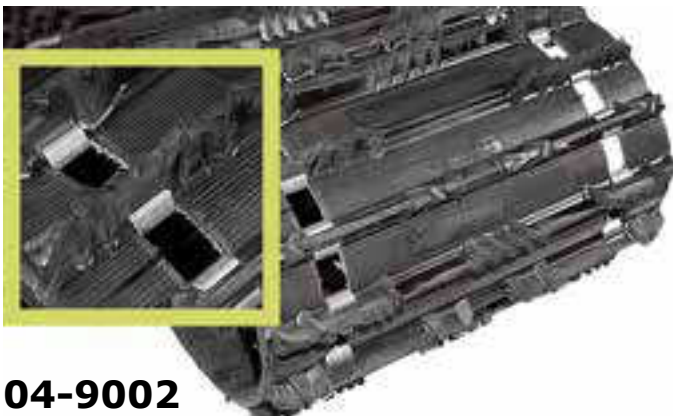

04-9002

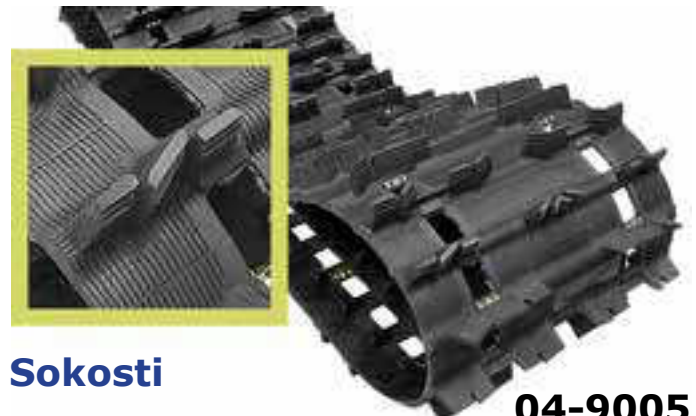

Sokosti

04-9005

Extending

04-3050
universal 12 cm



307cm ---> 325cm
325cm ---> 345cm
345cm ---> 365cm

25mm Welle

04-3060
Yamaha 12 cm



20mm Welle

04-3300
Lynx 20 cm



25mm Welle

320cm -> 345cm
330cm -> 345cm
Only LYNX!

04-3080
Yamaha 20 cm



307cm -> 345cm
325cm -> 365cm

20mm Welle

04-3040
universal



25mm Welle



25mm Welle

04-3070
To shorten Lynx G-type.
320 cm long boggie made
use track 307 cm long

04-3000 / Flip



345cm ---> 384cm
345cm ---> 403cm
365cm ---> 403cm ++
With the flip 30cm more

Aluminium-Profilen

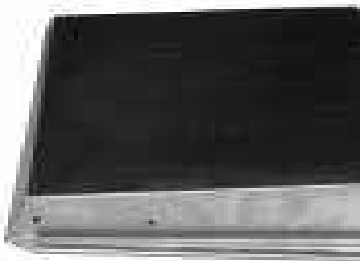

04-3001
Chassie 400-420 mm
Länge 400 mm

04-3002
Länge 400-410 mm
Länge 200 mm

04-3003
Chassie 415-430 mm
Länge 400 mm

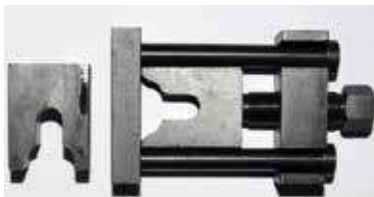

Track clip tool, bolt type
It will fit the 1 1/2" clips and
also the 1" clips with narrow
insert

Part# 38-100

Cleats



38-03

52



p/n	A	B	C
38-02	21	-	30
38-03	20	16	30
38-04	23	18	21
38-05	21	-	38
38-07	21	-	19
38-08	22	-	20
38-09	19	14	25
38-10	19	-	25



Antriebswelle 5900

11-59 Antriebswelle 5900

Für 1989-1995 Modelle



Hintere Welle

11-08	5492814	Hintere Welle	Lynx 250	
11-09	5493615	Hintere Welle	Lynx 5900	
11-12	05032389	Hintere Welle	Nordik 300, 377R	
20-5289		Befinden sich die Ritzel an der hinteren Welle, 9 oder 11 Zähnen und externes Laufwerk Raupe: Der einzige Weg, um eine Wiedergutmachung zu ersetzen ist a Raupe und Nutzung Ritzel 20-5289. Sie passen für interne Drift, 2,52 "Steigung. und auch 50 cm Raupe muss ein Losrad verwenden		
	20-5289			
11-60	extension	connection part to extend the tube		
Counter shaft				
11-20	5394111	Lynx 250S, 3900S		
11-21	5398073	Lynx 360S, Ranger		
11-22	539990	Fox -99		
11-23	5146138	Fox 00-		
11-25	875138073	Syncro connection part		

Haken



12-01 Universal



12-02 Skidoo



12-03 Polaris



12-05
Neu, Lynx



12-04
Skidoo

12-04XP
Skidoo -09-

No Slip Ritzel,

Patent Wahl Bros.

Pitch 2,52"



Nummer	Z	Pitch	Außen-Ø	Welle / mm	Hexa
39-00	7	2,52"	136 mm	25,0-27,0	24,0 mm
39-01	7	2,52"	136 mm	27,0-29,0	26,0 mm
39-02	7	2,52"	136 mm	32,0-34,0	31,0 mm
39-05	8	2,52"	158 mm	25,0-27,0	24,0 mm
39-06	8	2,52"	158 mm	32,0-34,0	31,0 mm
39-08	8	2,52"	158 mm	27,0-29,0	26,0 mm
39-09	9	2,52"	177 mm	27,0-29,0	26,0 mm
39-10	10	2,52"	197 mm	27,0-29,0	26,0 mm



39-15

Pitch 2,86"

Nummer	Z	Pitch	Outer dia	Welle / mm	Hexa
39-15	7	2,86"	155 mm	25,0-27,0	24,0 mm
39-16	7	2,86	155 mm	32,0-34,0	31,0 mm
39-17	7	2,86"	155 mm	27,0-29,0	26,0 mm
39-18	8	2,86"	181 mm	27,0-29,0	26,0 mm



39-43

Pitch 3,00"

Nummer	Z	Pitch	Outer dia	Welle / mm	Hexa
39-26	7	3,00"	163 mm	32,0-34,0	31,0 mm
39-27	7	3,00"	163 mm	27,0-29,0	26,0 mm
39-28	8	3,00"	190 mm	27,0-29,0	26,0 mm



21-08 PO

Pitch 2,52"

39-38	8	2,86"	181 mm	Rohrwelle	Polaris
39-39	9	2,52	177 mm	Rohrwelle	Polaris
39-42	7	2,86"	155 mm	Rohrwelle	Ski-doo, Lynx
39-43	8	3,00"	190 mm	Rohrwelle	Skidoo, Lynx-
21-08PO	8	3,00"	190 mm	Rohrwelle	Polaris

Anti-Stab wheel kit

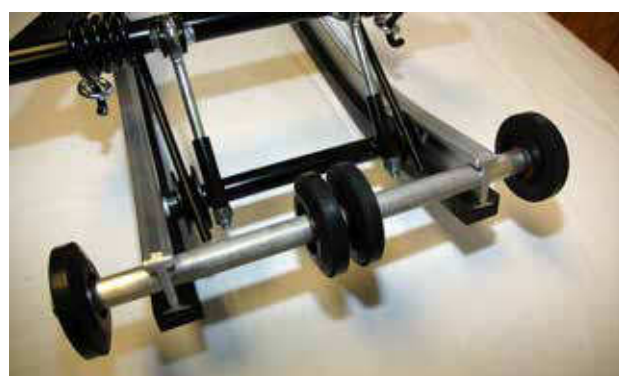

Stab Radsatz helfen zu verhindern, Raupe spearing durch die Verhinderung der Strecke kommen in contact mit den Spitzen der Hängeleisten.

39-791 Center, 223 mm shaft A-Cat, Yamaha
 39-793 Center, 220 mm, Ski-doo, Polaris, Lynx

Ritzel

21-07K	7	2,52"	136 mm	25,0-27,0	24,0
21-07N	7	2,52"	136 mm	square shaft	
21-08AC	8	2,52"	158 mm	25,0-28,0	24,0
21-08LY	8	2,52"	158 mm	32,0-34,0	31,0 mm
21-09LY	9	2,52"	177 mm	32,0-34,0	31,0 mm



21-08 AC

Ritzel

Nummer	Zahn	Pitch	Bearing	Beachten Sie
20-5285	9	50 mm	35-6205	Ockelbo, Breite 25 mm
20-5286	9	50 mm	35-6205	Ockelbo, Trapper, Breite 30
20-5287	11	50 mm	35-6205	Lynx, Nordik 300
20-5289	9	2,52"	35-6205	Raupe 9806, 9925, 9005
37-00	9	50 mm	-	Ritzel, Breite 22 mm
37-01	9	50 mm	-	Ritzel, Breite 30 mm
37-03	11	50 mm	-	Ritzel, Breite 30 mm
37-04	11	50 mm	hexa 27mm	Ritzel, Breite 30 mm
37-06	-	-	-	Wheel suspension 127 mm



37-06



20-5287



20-5289



20-5285



37-03



37-04

Inserts

20-34 insert 3/4 " pair

20-58 insert 5/8 " pair

Leiträder

Nummer	Durchmesser	Kugellager	Farbe	zu passen
20-127	127	35-620258	schwarz	Lynx
20-133	133	35-6004	schwarz	Lynx, Ockelbo
20-135F	135	35-6205	silber	Full moon, Ski-doo
20-135P	135	35-6304	silber	Full moon, Ski-doo
20-5630H	143	35-6205	silber	Arctic Cat
20-155	155	35-6205	schwarz	Skidoo, Trapper, Nordik
20-6380H	160	35-6205	silber	Polaris, Arctic Cat
20-6375S	160	35-6205	blau	Polaris, Arctic Cat
20-165H	165	35-6205	silber	Lynx
20-180	180	35-6205	silber	Lynx, 04-3000 flip
20-131	180	35-6204	schwarz	Yamaha
20-200	200	35-6205	schwarz	alle



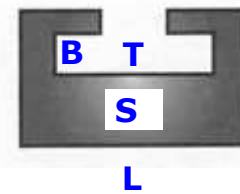
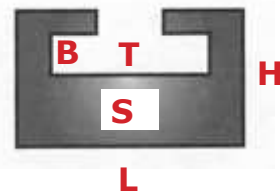

Gleitschienen

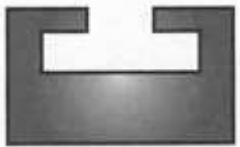

Arctic Cat	Breite L mm		Höhe H	Dicke S	B ,mm	T ,mm
	30		20	9,5	5	19
	Nummer	Länge cm	Farbe	Arctic Cat, alle Modelle nach -78		
	30-10	140	schwarz			
	30-610	140	graphit	Yamaha Viper 2013-		
	30-167	167	schwarz	Arctic Cat, Super Jag, Karibo		

Skidoo, Lynx	Breite L mm		Höhe H	Dicke S	B ,mm	T ,mm
	37,5		19	10	5	26
	Nummer	Länge cm	Farbe			
	30-01	140	schwarz	Lynx, up tp G-type, und alle		
	30-601	140	graphit	utility models		
	30-010	163	schwarz	Skidoo alte Modelle bis -96		
Trapper, Nordik	Trapper, Nordik-300,500,600					

Skidoo Nordik	Breite L mm		Höhe H	Dicke S	B ,mm	T ,mm
	37		20	10	7	24,5
	Nummer	Länge cm	Farbe	Nordik 377 R, 540, 550		
	30-00	155	weiß.			

Skidoo, Lynx	Breite L mm		Höhe H	Dicke S	B ,mm	T ,mm
	38		17	9,5	4,5	22
	Nummer	Länge cm	Farbe			
	30-21	140	schwarz	Lynx G-type-,		
	30-621	140	graphit	Skidoo REV, RT & RF, SC4 suspens.		
	30-210	163	schwarz			
30-321	140	gelb				

Skidoo, Lynx	Breite L mm		Höhe H	Dicke S	B ,mm	T ,mm
 höher Profil	38		15	7	5,4	27
	Nummer	Länge cm	Farbe	Formulat, GT mod., Mach1, Z, MXZ,		
	30-260	140	schwarz	Legend, MX Rev, Summit, Renegade		
	30-270	151	graphit			
	30-280	163	schwarz			
	30-360	140	gelb			
	Lynx 2009- RS 600, SC 4 suspension,					

Gleitschienen

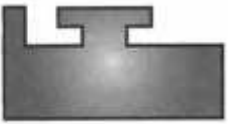
Polaris	Breite L / L mm		Höhe H	Dicke S	B ,mm	T ,mm
	31	37		11		
	Nummer	Länge cm	Farbe			
	30-15	140	schwarz	Up to 2000 all		
	30-615	140	graphit	XTRA 10, XTRA 12 narrow profile		
	30-150	145	schwarz			
note: dimensions	30-618	140	graphit	Polaris- Storm, XCR, breite Profil		

Polaris	Breite L mm		Höhe H / H	Dicke S / S	B / B	T / T
	32		19,5	22,0	9/ 11	5 / 6
	Nummer	Länge cm	Farbe	Edgr RMK 03-05, Edge 2000-05,		
	30-23	140	schwarz	340 mallit -99-05, Lite 97-98		
	30-623	140	graphit	Indy Sport -97-99,		
	30-230	167	schwarz	2000-		
note: dimensions	30-240	163	schwarz	gen II RMK, XC, M-10 , Indy Edge		

Yamaha	Breite L mm		Höhe H	Dicke S	B ,mm	T ,mm
	30			7		
	Nummer	Länge cm	Farbe	Phaser, Ovation, SRV, SS		
	30-12	140	schwarz			
	30-612	140	graphit			

Yamaha	Breite L mm		Höhe H	Dicke S	B ,mm	T ,mm
	30		15	7	5	24
	Nummer	Länge cm	Farbe			
	30-16	140	schwarz	Viking, Exciter 87-90, Phaser 90-99		
	30-616	140	graphit	V-max 92-97,		
				V-max 500-600 94-96		

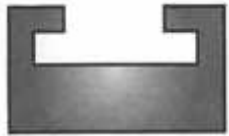
Yamaha	Breite L mm		Höhe H	Dicke S	B ,mm	T ,mm
	30		18	10	5	24
	Nummer	Länge cm	Farbe			
	30-20	140	schwarz	V-max 97-03,		
	30-200	145	schwarz	Mountain max 97-02		
	30-620	140	graphit	SX, SRX, SXR, 98-04		

Yamaha	Breite L mm		Höhe H	Dicke S	B ,mm	T ,mm
	34		18	10	5	25
	Nummer	Länge cm	Farbe			
	30-625	145	graphit	RX1 models 2005- RS models 2005-		
	30-635	157	graphit	Apex, Attack 2006-		
				Nytro 2006-		

Arctic Cat



07-100 01
JAG 87-91, 0109-926

Polaris:



07-100 05
VM 38 SS, 3083171

Rotax



07-100 10
VM 34 straight

Vergaser Adapter



VM 30, 32, 34 HD
07-100 13



07-100 06
VM 32, 34, HR, 3083306

Yamaha



07-100 13
VM 30, 32, 34 HD



07-100 13
VM 30, 32, 34 HD



07-100 12
VM 570.1261.00



07-100 13
SKID. VM 30, 32, 34 HD



07-100 20
TUNDRA VM 34



07-10021 MX 85-92



07-100 22
VM34,79-84, 570.1339.00



07-100 23
VM 40, 44, 570.038.200



Neu, neu

43-27

Sprocket **8751-46293**

27 Zähne Jahr 1989-1997

Lynx 5900, 3900, 6900



**43-68 600cc Flüssigkeit abgekühlt
Jahr 2002-05**

Sprocket **Z=53 8751-56114**

Sprocket **Z=31 8751-56156**

Sprocket **Z=28 8751-56206**



43-32

Sprocket **8751-46042**

32 Zähne

Jahr 1989-1996

Lynx 5900, 3900, 6900



Syncro Getriebe

43-65

von 1992

sprocket, breit z=64 8751-55048

sprocket, links z=33 8751-47643

sprocket, rechts z=33 8751-47644

43-64

bis 1992

sprocket, breit z=64 8751-55048

sprocket, links z=31 8751-47202

sprocket, rechts z=31 8751-47203



Sisu Getriebe

43-66

1996-2003

sprocket Z=55 8751-56048

sprocket Z=31 8751-56049

sprocket Z=28 8751-56050

41-3000, 9mm	41-3281, 8 mm
	Lynx 250, 3900
	Lynx 5900

41-8797, 10 mm	41-8796, 9 mm
	Ranger, 5900, ym

Ab. 20% stärker	40-PZ
	12 mm
	Nytro
	Phazer 07-

Kurzen Draht länger als 40-PZ	40-LT
	Mt Lite

8-wendet, 11,5 mm	40-POLA
	Polaris
	Skidoo
	Lynx

9-wendet, 11,0 mm	40-PO
	Polaris 90-

Edge suspens, 11,0 mm	40-EDGE
	Polaris
	Skidoo
	Summit

F. hinten	40-4716
	Nordik 300
	Skidoo
	40-0310,
	F. vorne

F. vorne	40-CA
	Karibo
	Arctic Cat

wie	
40-POLA	40-AC, 11,5 mm
	AC, neueste
	40-VI, 12,0 mm
	Yamaha Viking

	41-1530, 9 mm
	Lynx 5900
	mit Ring
	40-4715, 8,5 mm
	Nordik 500-600

Federn hinten	41-8805
	Ranger
	Lynx 5900

Federn hinten	41-4175
	Lynx 3900

Federn hinten	41-4277
	Lynx 5900
	10,0 mm

Federn hinten	41-4500
	Lynx 5900
	9,0 mm

Federn hinten	40-4721
	Nordik 540
	Trapper
	41-1531
	Lynx 5900

mit Haken 11,5 mm	40-POL
	Polaris
	up to -89

Rechte Hand Federn in den Bildern gezeigt.

11 Breite	Länge	13 Breite	Länge	15 Breite	Länge
45-064	64	46-064	64	50-064	64
45-066	66	46-066	66	50-066	66
45-068	68	46-068	68	50-068	68
45-070	70	46-070	70	50-070	70
45-072	72	46-072	72	50-072	72
45-074	74	46-074	74	50-074	74
45-090	90	46-076	76	50-076	76
		46-102	102	50-078	78
		46-104	104		
		46-106	106		
		46-108	108		

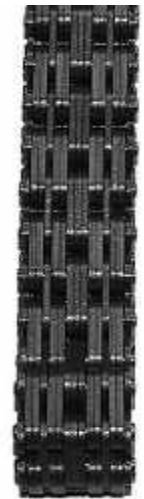

Silent Kette

3/4" Hyvo Kette

7/8" Hyvo Kette

3/4" Breite	Länge	3/4" Breite	Länge		7/8" Breite	Länge
52-66	66	52-80	80		53-70	70
52-68	68	52-82	82		53-72	72
52-70	70	52-86	86		53-74	74
52-72	72	52-90	90		53-76	76
52-74	74	52-92	92		53-78	78
52-76	76	52-94	94		Original	
52-78	78				Borg Warner Kette	

Kettenräder, Skidoo, Lynx

11 Breite	Z	13 Breite	Z	15 Breite	Z	Low 13	Z	Low 15	Z
45-016	16	46-016	16						
45-017	17	46-017	17			55-43	43	58-43	43
45-018	18	46-018	18			55-44	44		
45-019	19	46-019	19	50-019	19	55-45	45	58-45	45
45-020	20	46-020	20	50-020	20				
45-021	21	46-021	21	50-021	21				
45-022	22	46-022	22	50-022	22				
45-023	23	46-023	23	50-023	23				
45-024	24	46-024	24	50-024	24				
		46-025	25	50-025	25				
		46-026	26						



Kettenräder, 7/8"-13 spline

Arctic Cat alle, nicht Diamond Drive, Polaris bis 1996





11-Breite	Z	11-Breite	Z	13-Breite	Z	13-Breite	Z
47-016	16	47-021	21	48-016	16	48-021	21
47-017	17	47-022	22	48-017	17	48-022	22
47-018	18	47-023	23	48-018	18	48-023	23
47-019	19	47-024	24	48-019	19	48-024	24
47-020	20			48-020	20		

Arctic Cat	Arctic Cat	Arctic Cat	Arctic Cat
05-15225 Paar	05-15232 Paar	05-15240 Paar	05-15241 pc
0109-932	0115-603	0702-264	0702-229
			
Arctic Cat	Polaris	Polaris	Polaris
05-15244 Paar	05-15214 pc	05-15231 pc	05-15237 pc
0702-563 v. 2006-	1930 723	1930 588	1930 586
			
Polaris	Polaris	Polaris, 2201430,	Polaris
05-15243 Paar	05-15255 Paar	05-15251 Paar	05-15254 Paar
1930 723	220 1567, 2001-		2003-2011 IQ, Indys
			
Polaris	Polaris, 220 1429	Skidoo, Lynx	Skidoo
05-15203 Paar Paar	05-15252 pair	05-15235 Paar	05-15247 Paar
193034 7/5		Nordik	860.701.700
			
Skidoo, Lynx	Skidoo, Lynx	Skidoo, Lynx	Skidoo, Lynx
05-15212 Paar	05-15242 Paar	05-15246 Paar	05-252FM, Paar
860.701.400	860.700.700	414.990.900	507-032-473
			
Lynx		Lynx	
85-184 St		85-183 Lynx 5900	Lynx 85-162
1986-1993		Lynx 535, 3900, 650	Lynx 535, 3900, 650
			

Bremsklötze

Yamaha 05-15224 Paar	Yamaha 05-15249, 05-15250	Yamaha 05-15226 St	Yamaha 05-15228 St
			
Yamaha	05-15245 kpl	Yamaha 05-451FM	Yamaha 05-450FM
			nicht Foto Vector, Phazer 2006-
Ockelbo 85-179	15-00 Velsa Kupplungsfeder	37-08 Ockelbo Gummifeder	
			

Haubenschloß

Aktiv	12-131	Lynx, Yamaha	12-13402	Polaris	12-135
					
Polaris	12-13501	Arctic Cat	12-130	Skidoo	12-132
					

Skidoo 12-261

Skidoo 12-260

12-165 Spiegel

Aufkleber

00-600



00-601



Windschutzscheiben

00-110	5393062	00-140	5393890-1
	GL 250 - >88		Lynx 640
00-111	524090X	00-141	6500202-2
	GL 250 S, GL 230 89->91		Lynx 650 smit Schrauben 95
00-112	526754	00-142	533084X, Stahlbügel
	GL 360 S 92->95		Lynx 650 met. 83->94
00-115	539504	00-151	537644
	Forest Fox 96->98, 01		RANGER, LIGHT, GT 93->97
00-120	522842X, Stahlbügel	00-181	5241686 Skandic 500
	GL 3900, GLX 5900 low->93		5900 96-99, 6900 Alpine III
00-121	538284-1	00-300	Nordik 300
	GLX 5900, mit Schrauben		
00-122	523192X, Stahlbügel	00-377	Nordik 377 R
	GLS 3300 low		
00-123	538616	00-500	Nordik 500, 600, 7 Schlitze
	GLX 5900, Schlitze 1995		
00-130	524126X, Stahlbügel	00-510	Trapper, 5000, 5 Schlitze
	GL 3300, GL 3900 S, 88->92		
00-535	Lynx 535	00-550	Nordik 550, 540
	Lynx 535, alle		

Benzinpumpen



31 l.

08-188



70 l.

08-200



08-187



Primer Filter, in tank



03-7000, no tube
03-7000A, w. tube



03-7311

Start Federn

01-1560	Rotax	414 783 400
01-158	Rotax	420 939 115
01-2080	Arctic Cat	3001-077
	Polaris	308-3185
	Yamaha	8YO-15713-00-00
01-207	Kohler	



Repair kit

(MIKUNI)

08-103 Mikuni (07-187-05)

08-104 Mikuni (07-187-11)

Pawl kit Rotax



01-154

Throttle extension kit ab.20 cm 03-5000



Starter-Motoren

Passend für; OEM p:no

01-0192



DG-0058-1
9-tooth
Drive gear



CB-0092-10
Brush holder
Assembly



Polaris:
417 0006, 241 0748

01-0201



DG-0058-1
9-tooth
Drive gear



CB-0092
Brush holder
Assembly



Arctic Cat:
0745-018, 0745-030,
0745-052, 0745-257
0745-357
1991-2007

01-0202



CB-0092-1
Brush holder
Assembly



Arctic Cat: 0645-183
0654-312, 0645-578
1995-2002

01-0203



CB-0092-10
Brush holder
Assembly



Arctic Cat: 0745-143
0745-126, 0745-356
2001-2007

01-0204



DG-0091-1
8-tooth
Drive gear



CB-0210
Brush holder
Assembly



BRP: 515-176-003
515-176-113, 515-175-562
515-175-843
2000-2007

01-0205



neu!!!

BRP: 410-212-400

01-0206



DG-0092-1
9-tooth
Drive gear



CB-0063
Brush holder
assembly



Yamaha:
8BB- 81800-01-00
8BB- 81800-00-00
8Y3- 81800-51-00
1988-2005

01-0207



DG-0093-1
9-tooth
Drive gear



CB-0140-1
Brush holder
Assembly



Yamaha:
8CW-81800-00-00
8CW-81800-01-00
1997-2003

01-0228



DG-0095-1
9-tooth
Drive gear



CB-0140-1
Brush holder
Assembly



Kubota:
Kubota: 70000-65440
Denso: 228000-6910
Denso: 228000-6911
BRP:

01-0229



DG-0095-1
9-tooth
Drive gear



CB-0140-1
Brush holder
Assembly



410-207-500
Lynx, Skandic Rotax 494
1997-2000

CDI-Zündboxen



01-14342
Rotax 410.918.900



01-14343
Rotax 420.965.591



01-401
Arctic Cat 3004-099



01-14340
Rotax 420.866.595



01-415
Yamaha 8V0.85540.21



01-407
Polaris 3083725



01-14345 Skandic 500 AIII
Rotax 420.965.757



01-40701
Polaris 3083989



01-40801
Polaris 3084007



01-14329
Arctic Cat 3003-777



01-14372
Skidoo 512.058.927 Form.

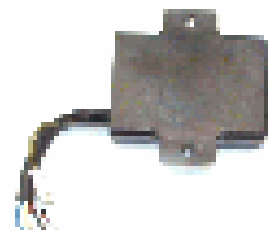

01-406
Pol. 3083721 600-650



01-404
Polaris 308 3723



01-14327
Arctic Cat



01-14332
Bosch, Skidoo, Motoski

Zündspulen



01-14310
Rotax 410.916.000



01-14311
Rotax 410.913.500 Arctic



01-14319



01-14312
Arctic Cat 3003-221



01-14313
Polaris 3082974



01-143120
Arctic Cat 3003-977



01-14314
Yamaha 8W3.82310.10



01-14315
Yamaha 8E7.82310.10



01-14317
Yamaha 5.82310.40



01-14351
Yamaha 8AB.82310.10



01-14353
Arctic Cat 3003-575



01-14355
Rotax 10.920.500



01-14350
Yamaha Bravo 250 -88



01-14363
AC 3005-381 ZL-ZR 5-700



01-14371
Rotax 420.996.705
Form. III, Mach1, Z, ZR

Zündspulen



01-14360
Arctic Cat 3004-126



01-14361
Arctic Cat 3004-483



01-14362
Polaris 3084469



01-1430
Rotax, Bosch, Arctic Cat



01-14367
Polaris 3085293



01-14370
Formula 415.085.400

Sicherheitsstopp swicth



01-113 Arctic Cat



01-11120
Skidoo

01-11121
Skidoo 515.1515.00



01-11113
Yamaha, Arctic Cat, Polaris



01-112



01-120
Universal, oldies
Push-stop-modell

Zündkerze



BOSCH

05-B8
05-B9

BR8ES Widerstände Typ
BR9ES Widerstände Typ

Spannungsregler



01-15416 3 wires
01-15416B 4 wires



01-15402
 Rotax 410.908.900



01-15406
 Rotax, Arctic Cat

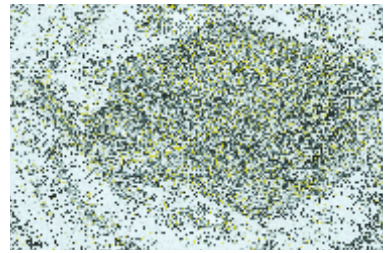

01-15421
 Polaris 4060122



01-15417 250 W
 Rotax



01-15415
 Rotax 410.908.900



01-15436
 Yamaha 98A.81910.00



01-15418
 Arctic Cat



01-15426
 Arctic Cat 0232-014



01-15432
 Yamaha 82F.81910.

Zündkerzenkappe



01-15435
 Yamaha 82M.81910.AO



01-110



01-1101



01-100
Ladegerät 12V

Kunststoffski (kommen unter den original Ski 31-*) Gleitstäbe normal, mit Hartmetall (coromant) und racing (rot)

	normal
	MM274
	coromant
	MM144
LYNX: Blade DS; 2016	31-12

	normal
	MM290
	coromant
	MM190
LYNX: Blade	31-11

	normal
	MM274
	coromant
	MM144
Ski-doo: Pilot DS2	31-10

	normal
	MM274
	coromant
	MM144
Ski-doo: Pilot DS3	N/A

	normal
	MM274
	coromant
	MM144
Ski-doo: Pilot narrow	31-04

	normal
	MM274
	coromant
	MM144
Ski-doo: Pilot L & R	31-03L&R

	normal
	MM243
	coromant
	MM186
Lynx: ADJ suksi	31-03

	normal
	check
	coromant
	check
universal	31-01

	normal
	MM238
	coromant
	MM198
Polaris: Pro Steer	31-09

	normal
	MM238
	coromant
	MM198
Polaris: Gripper	31-09

	normal
	coromant
Polaris: Pro-Float ski	N/A

	normal
	MM239
	coromant
	MM139
Yamaha: Viking III	31-05

	normal
	MM263
	coromant
	MM158
Yamaha: Viper (Cat)	31-02

	normal
	double...
	coromant
	-
Yamaha: N/A	N/A

	normal
	MM263
	coromant
	MM158
Arctic Cat: 2013-	31-02

	normal
	MM239
	coromant
	MM139
Yamaha: Viking IV	N/A

Extra breite Skier

Vuotsolainen

Nummer	Breite mm	beachten Sie	Passend für
31-00	250		Alpine,
31-01	250		universal
31-02	200		universal
31-03	225		Kunststoff-Ski, ADJ
31-03R/L	225		pilot ski, recht-links
31-04	200		pilot schmal
31-05	225	mit Bohrungen	Yamaha
31-09	225	Bohr, Polaris	Polaris, Arctic Cat
31-10	240	mit Bohrungen	Lynx, Skidoo DS 2 pilot
31-11	230	mit Bohrungen	Lynx, SLP ski



**Nur 70 cm weichen Schnee.
Wenn die Ölwanne nicht
Schiebetüren auf dem Schnee,
werden Sie ins Schwitzen.**

31-01

31-02

31-03

31-03R / 31-03L



Extra breite Skier

Vuotsolainen

31-04

31-05

31-09

31-10

31-11



Plastics für Stahl Ski

8 mm HPDE.



32-01

Arctic Cat



32-00

Ockelbo



32-99

Safari, Scandic 380



32-61

Lynx



32-51

Polaris -92, Ockelbo



32-88

Yamaha Phaser 98-



32-06

Arctic Cat



32-11

Trapper, Nordik



32-21B

Formula, Snowexpert



32-41

Polaris 1993-



32-81

Yamaha Viking



32-91

Yamaha V-max 94-



31-01

Vuotsolainen

Plastics für Kunststoff-Ski



33-40

Polaris



33-60 Skidoo / Lynx flex



33-20

CTRL ski,



33-50 Pilot, narrow



33-10

Arctic Cat



33-80 Yamaha SRX 1998-



33-90

Yamaha 2000 /Skidoo / Lynx



33-99 Yamaha RX-1

31-06 Plastic sheet
6 x 800 x 1000 mm

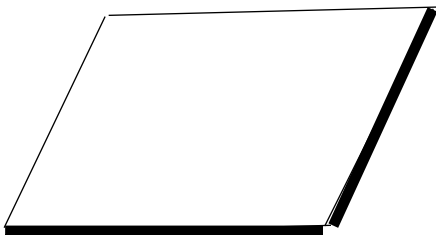

Überprüfen Sie auch
www.teolehtimaki.fi

31-00

Alpine II

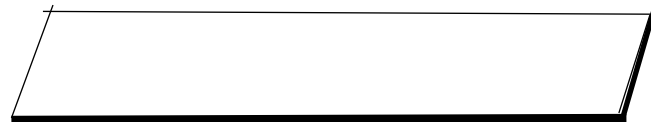

Plastic sheet

31-07

8 x 150 x 3000

31-07A

8 x 300 x 3500

31-08

8 x 150 x 2000

Runners, 12x12 Wear resistant steel

The runners are made of 450 Brinell wear steel, it wears evenly and not grab the stone, like a normal coromant runner. Long, up to three times the service life - less exchange work.

P/N	Replace	Length	A, mm	B, mm	C, mm
MS498	MM298	460	115	180	



P/N	Replace	Length	A, mm	B, mm	
MS490	MM290	470	179	90	



P/N	Replace	Length	A, mm	B, mm	C, mm
MS444	MM244	335	160		

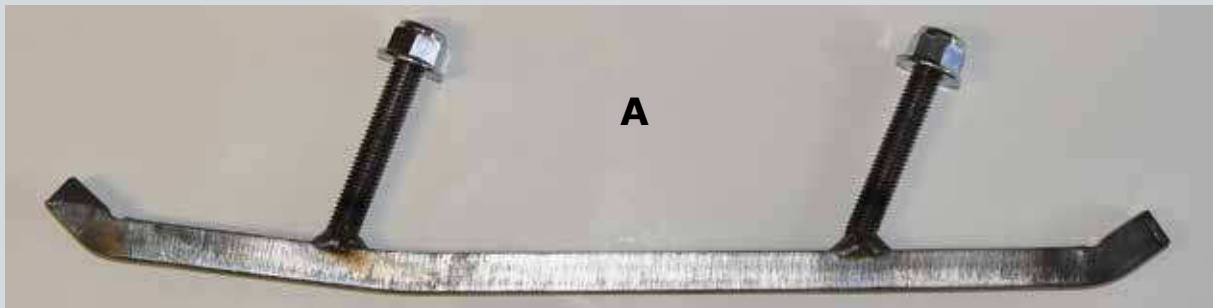

P/N	Replace	Length	A, mm	B, mm	C, mm
MS439	MM239	530	90	180	90

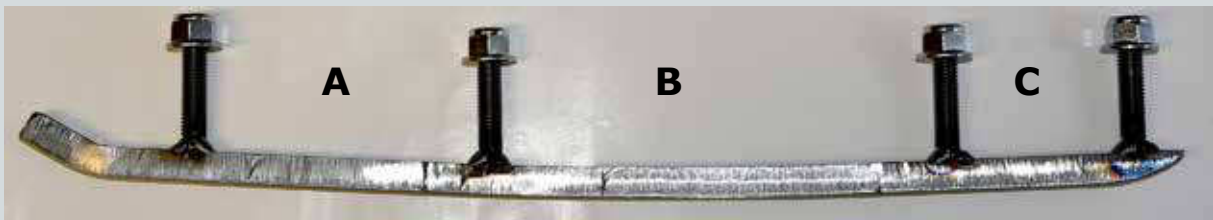



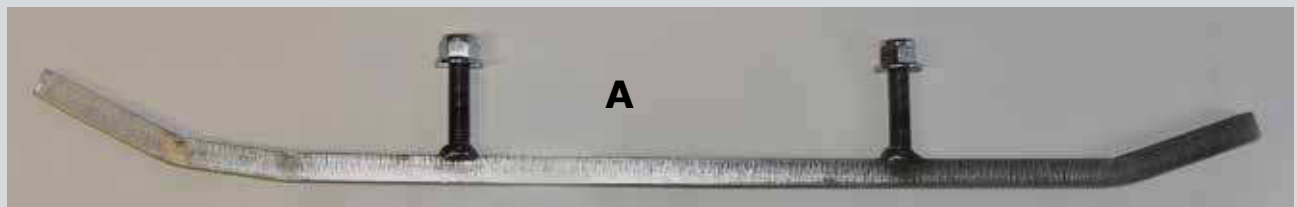







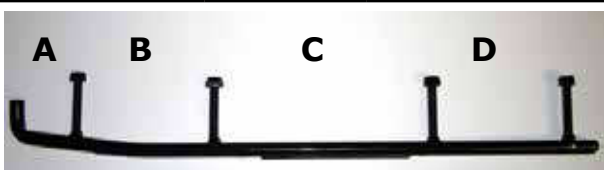
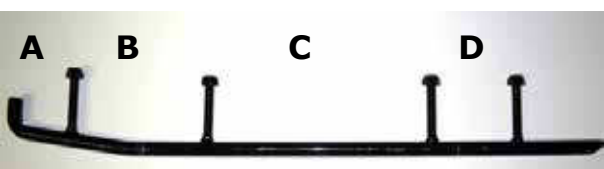

P/N	Replace	Length	A, mm	B, mm	C, mm
MS443	MM243	520	192		



ARCTIC CAT

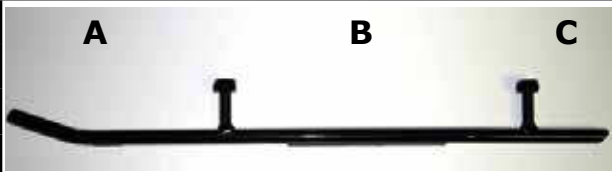
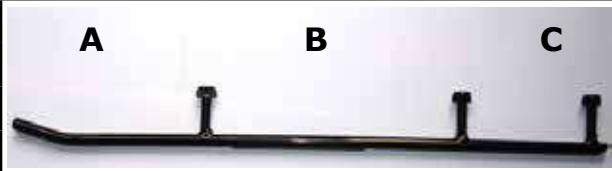
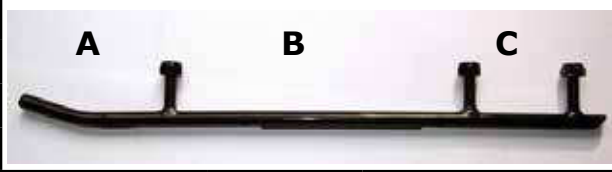

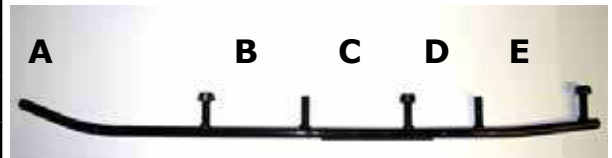
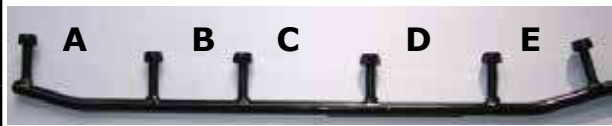
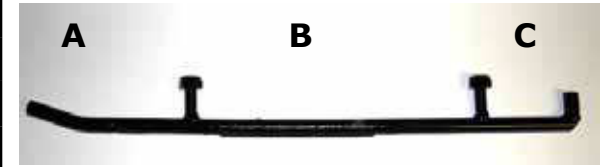
Gleitstäbe

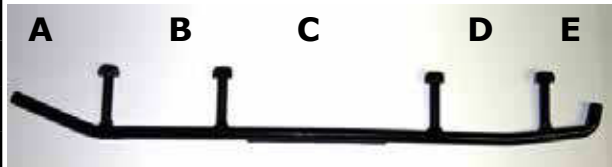
Normal	Racing	Carbide	L=länge	A	B	C	D	E	
MM203		MM169	772	386	386	-	-	-	
			AKTIV: Alaska, Panther, Karibo 1984-1986, lisäksi ARCTIC CAT: El Tigre 1980-84, Jag 1980-91, Panther 1980-89, Super Jag 1987-92 Trail Cat 1980-81, Pantera 1980-85						
MM205		MM170	776	343	433	-			
			Cheetah Tour 1987-91, Cougar 1987-91 El Tigre 1987-90, Jag AFS 1989-91 Manx 1991-, Pantera 1987-90 Panther 1990-91, Wild Cat 650 1988-90						
MM262		MM157	469	57	114	178	114		
			Plastic skis 1996-						
MM263		MM158	469	57	114	178	70		
			Plastic skis 2005-??? Auf den Fotos ist die Front des Gleitstäbe auf der linken Seite, immer.						
MM290	MM390	MM190	470	89	179	90	112		
SLP & Blade ski			MS490, Wear resistant steel						
									
OCKELBO									
MM207		MM160	800	395	405				
			All makes. -1986 Ockelbo						
MM228		MM162	450		270				
			All makes. 1987- Ockelbo						
TRAPPER, NORDIK									
MM215		MM176	527	238	177	112			
			Nordik 300-377 Nordik 500-600 Nordik 540-600 SL						

Normal	Racing	Carbide	L=länge	A	B	C	D	E	
MM242		MM189	470	170	235	65			
			Forest Fox 1999-, GL360, 250 1991-93, GL 2300 -90 GL 3300 1989-90, GL 3900, LTS 1991-92 GLS 3900 1989-90, GLX 5900, LTS 1991-93 GL Sport, LTS 1991-92, Ranger 1993						
MM230		MM187	550		235				
			GL 250. 250S 1986-89, GL 3900 1983-88 GL 5900 1983-90 535, 650 1983-87 640 1988						
MM240		MM188	450		228	81			
			GLS 3300 1986-89, GLS 3500 F/C 1990-93 GLS 3600 L/C 1990-91, Cobra 1992-93 3800 Rave, Ultra, Cobra Touring, Rave , Cobra Racing, Enduro 1993						
MM241			450		219				
			230, 250, 650 1989-93						
MM265		MM154	660	215	110	114	80	122	
			G-type Rave 1997-99 Enduro 600						
		MM153	530	120		115	110	80	
			G-type Racing 1998- Sport XR 98						
		MM152	440	130	228	77			
			G-type 1997-99 Enduro 500						
MM250		MM193	625	321	241	63			
			Ranger short steel ski of Skidoo 2000-						
MM279		MM146	537	90	103	190	103	54	
			FLEX plastic ski 2000- Also fits Skidoo						

LYNX

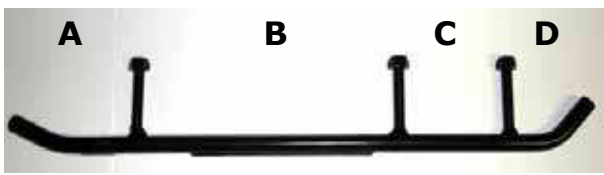
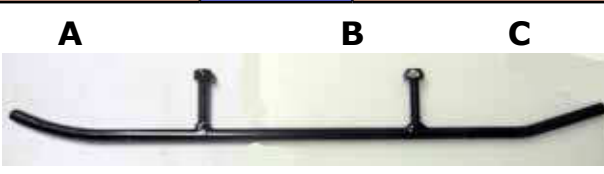
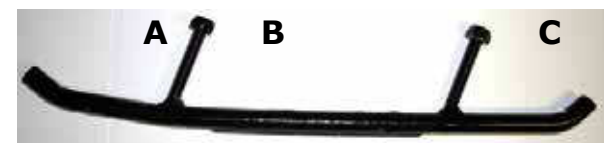
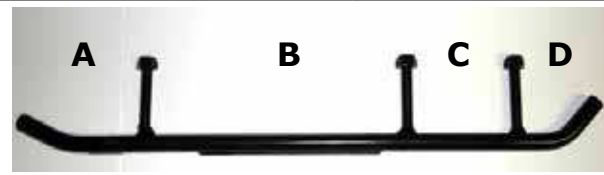
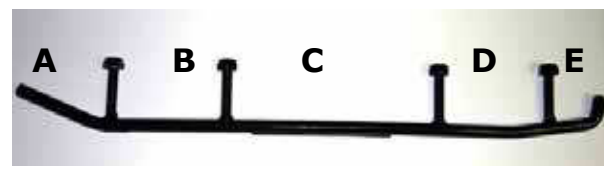
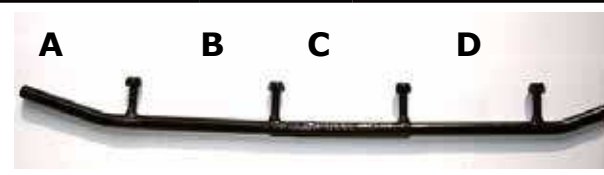
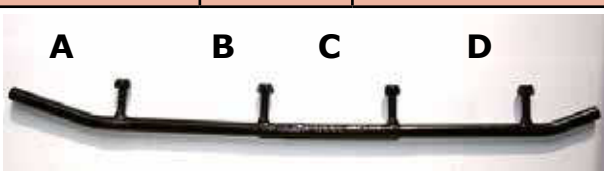
Gleitstäbe



Normal	Racing	Carbide	L=länge	A	B	C	D	E	
MM277		MM147	400	87	177	75	60		
			Plastic, Camoplast ski 2003- Also for Ski-doo and Polaris						
MM243	MM386	MM186	520	210	192	121			
			ADJ suksi, CTRL suksi 2003- MS443, Wear resistant steel						
SKI-DOO									
MM274		MM144	335	89	160				
			Pilotti ski/ Ski-doo, Lynx Blade Ds ski MS444, Wear resistant steel						
MM277		MM147	400	87	177	75	60		
			Plastic, Camoplast ski 2003- Also for Ski-doo and Polaris Skandic 380-550 2003-						
MM279		MM146	534	84	103	190	103	54	
			Plastic ski FLEX 1997- Also Lynx						
		MM141	445	54	95	222			
			Formula 583 1998 Formula III 600, 700 1997-99 Formula Mach I, Z 1997-99, Formula Z 1997-99 G-Touring 583, 670 1997-99, Summit 1997-99						
		MM142	502	90	126	110	116	60	
			MXZ 440, 583, 670 1996-99						
MM250		MM193	625	321	241	63			
			Formula 500, DL 1996-99 Formula 583 1996-99, Formula S, SL, SLS 95-99 G-Touring 500 1996, Scandic 380, 500 1995-						

SKI-DOO

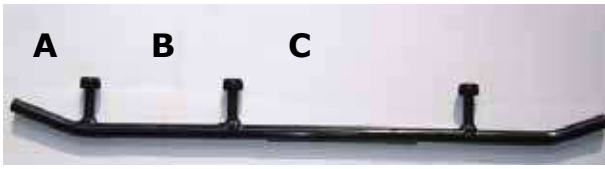
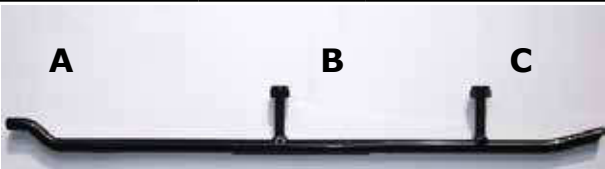
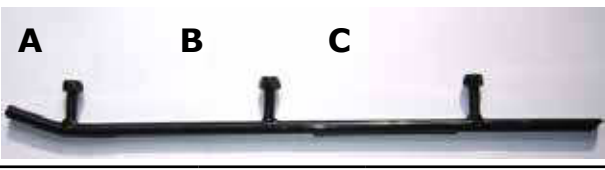
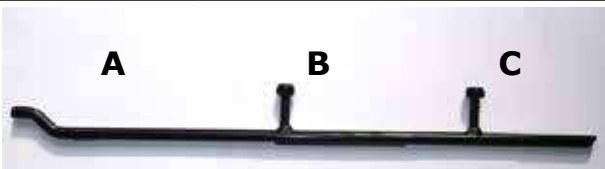
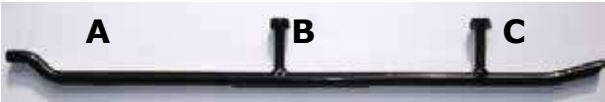
Gleitstäbe

Normal	Racing	Carbide	L=länge	A	B	C	D	E	
		MM143	495	54	120	196	115		
			Formula III 1985-96, Formula Mach Z 1985-96 Formula MXZ 1993-95, Formula Z 1994-96 G-Touring 583, 670 1993-96 Summit 1994-96						
		MM229	602	248	176				
			Formula SP DL 1985-86, Tundra 1985-97 Safari 377, 447, 503 1984-88 Safari, Saga, Scout 1989-92 Skandic 377, 503 1986-87						
		MM216			170	170	99		
			Formula Mach I 1989-94, Formula SS 1995-96 Formula MX, XTC 1985-95 Formula Plus, XTC 1985-93 Formula ST, STX 1994-96, Grand Touring 470 -95 Safari DL, 503 Rally 1993-94, Safari GLX, LCE, L 1990-94, Skandic II 377, 503 92-94						
		MM275			178	114			
			Blizzard 1978-84, Nordik 1981-83 Everest 1974-83, Olympique 1976-79 Skandic 277, 377 1982-85 TNT 1973-78						
		MM215			238	177	112		
			Safari Cheyenne 1989-91 Alpine II 1991-95						

POLARIS

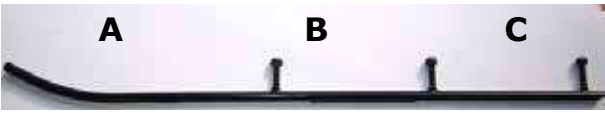
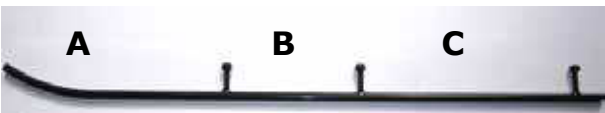
Normal	Racing	Carbide	L=Length	A	B	C	D	E	
	MM348	MM148	722	180	160	178	178		
			Plastic skis 2007- Replaces original MM348 racing runner						
		MM270			310	178	178		
			Plastic skis 1997- Indy RMK 700, Indy XC 400, Indy XCR 600 1997- Indy Storm, Indy Ultra 1997-						
		MM206			317	178	178		
			All makes 1988-98 All with steel skis 1998-99 Indy Sport 1987						
		MM209			317	178	255		
			Indy 400, 600, Trail, Longtrack, Sprint SS, Star, Startrack 1986-87						

POLARIS

Gleitstäbe

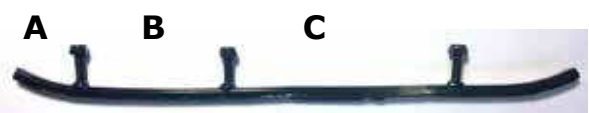
Normal	Racing	Carbide	L=Length	A	B	C	D	E	
MM238	MM398	MM198	460	60	115	180			
			Polaris Gripper ski						
			MS498, Wear resistant steel						

MS498

YAMAHA

Ski runners

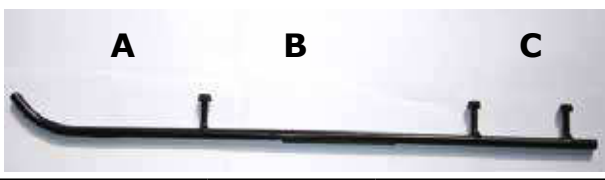
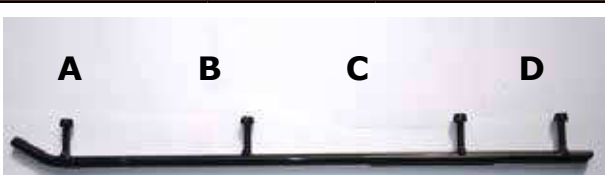
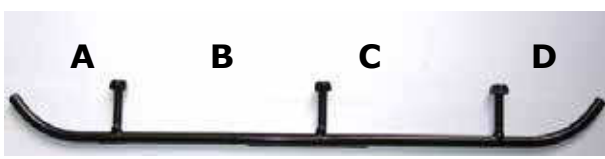
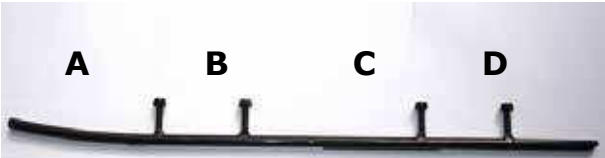
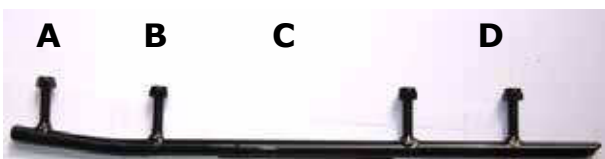
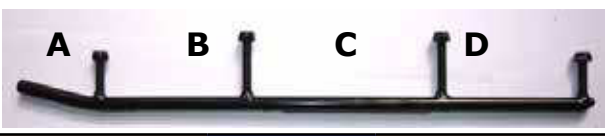
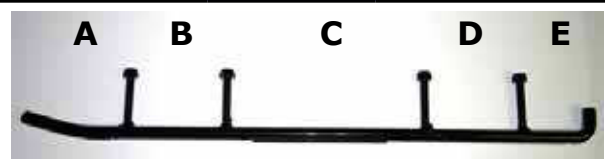
Normal	Racing	Carbide	L=Length	A	B	C	D	E	
224		MM164	635	216	292	101			
			Exiter 570 1987-90						
			SR 540, V-MAX 540 1987-91						
MM232		MM166	663	57	183	210	101		
			CS 340 1990-99, Exiter II 570, SX 1991-93						
			Phazer II, E, ST 1984-99, SR 540 1985-86						
			V-Max 540 1983-86, Viking II 540 1988-92						
			XLV 540 1985-91						
MM235		MM175	604		181	210			
			ET 410 TR 1992-99						
			Viking II 540 E 1993-99						
			Venture 480 1991-99						
MM251		MM194	608	159	90	185	90		
			V-Max-4 1992-94						
			Venture 500,600,700 1995-96						
			V-Max 500, 600, 700 1994-96						
			V-Max 800 1995-97						
MM281		MM136	419		82	176	59	62	
			V-max 500, 600, 700 1997-99						
			Venture 500,600,700 1997-99						
282		MM135	475		124	160	118		
			SRX 600, 700 1998-						
MM239	MM339	MM139	530	100	90	180	90	70	
			RX, RX-1 2002-						
			MS439 Wear resistant steel						

MS439

Kutzer Alpine Technologie

Sonnenstr. 1

D-86980 Ingenried

Tel: +49 (0)1637552442

Fax: +49 (0)8868 180 211

mail@motor-schlitten.de

www.kutzer.biz

www.Kutzer.biz

Alpine Technologie

Vermietung

Loipen- Pistengeräte

Motorschlitten & Quad

Tel: 0163 755 24 42

mail@motor-schlitten.de



