



two-thousand twelve

ARCTICWEAR & ACCESSORIES

POGA REFERENCE GUIDE

Effective February, 2012

Table of Contents

General POGA Information	1
Catalogs and Brochures.....	1
Using This Guide.....	1
Kit Instructions/Components.....	1
Track Exchange New Vehicle - Track Take-Off	1
High Altitude Kit Exchange	1
Tunnel Replacement and Tunnel Stamping	1
ATV Frames.....	2
Warranty.....	2
Telephone Numbers.....	3
Ordering	3
Shipping	5
Promotional Products	5
Fixtures/Point of Purchase Products	5
World Class Store	5
Equalized Freight.....	6-7
Ignition Keys.....	8
Sizing Charts.....	9
Arcticwear Size Ratios	10
Accessory Bag Dimensions	11
Kit Installation Times	12-13
Covers.....	14-15
Touring Bags.....	16-18
Touring Accessories	19-21
Windscreens	23
Custom Accessories.....	25-31
Mountain Accessories	32-36
Utility.....	39-37
120.....	44
Tracks.....	45-46
Wearbars.....	47-48
Traction & Control	49-53
Oil & Care.....	54-58
General Maintenance.....	59-66
Helmet Parts	67-71
High Altitude Kits.....	72
2012 Optional Rear Suspension Springs.....	72
Drive Belts	74-75
Fixtures	76-77
Point of Purchase.....	78-79
Fixture Accessories.....	80-83
Index.....	84

Ignition Keys

■NOTE: The information listed below will help on ordering any replacement keys. On most models, the key identification number is stamped on the key. Record this number in the space provided in the Operator's Manual as well as on the sales receipt during each sale for reference if a consumer ever needs to replace or copy a key.

ATV/ROV Keys

2006-Present ROV

2008-Present 400-1000 ATV (except 425)

0430-042	Left-Side Groove with key codes of 4000-4149
0430-043	Right-Side Groove with key codes of 4150-4299

■NOTE: A dealer can order blank keys and get them cut as long as they have the original key to copy. If the customer has lost both keys, the ignition switch assembly must be replaced.

■NOTE: If a dealer wants Arctic Cat to cut the key, the dealer needs to order a Key (p/n 0409-003). Dealer must then enter the 4-digit key code (4000-4299) found on each key.

1996-2007 ATV (except 2006-2007 250); 2011-Present 350, 366, & 425

0409-059 - A-Series	3409-011 - D-Series
0409-060 - B-Series	3409-012 - E-Series
3409-007 - C-Series	3409-013 - F-Series

■NOTE: A dealer can order blank keys and get them cut as long as they have the original key to copy. If the customer has lost both keys on a 2005 and later ATV, the ignition switch assembly must be replaced.

■NOTE: If a dealer wants Arctic Cat to cut the key for a model prior to 2005, the dealer needs to order a Key (ex: p/n 0409-059). Dealer must then enter code letter and 5 numbers (ex: E12345). Code can also be found on the ignition switch.

2006-Present 50, 90, 250, and 300

3304-520	Right-Side Cut
3304-521	Left-Side Cut

■NOTE: Hold the key pointing downward and the cut side is the narrow side. This will determine if the key is a right or left cut key.

■NOTE: A dealer can order blank keys and cut them as long as they have the original key to copy. If the customer has lost both keys, the ignition switch assembly must be replaced.

■NOTE: If a dealer wants Arctic Cat to cut the key, the dealer must order Key (p/n 0409-003). Dealer must specify the three digit code and specify if it is a left or right cut key.

Snowmobile Keys

2010-Present 4-Stroke Snowmobile

0430-042	Left-Side Groove with key codes of 4000-4149
0430-043	Right-Side Groove with key codes of 4150-4299

■NOTE: A dealer can order blank keys and get them cut as long as they have the original key to copy. If the customer has lost both keys, the ignition switch assembly must be replaced.

■NOTE: If a dealer wants Arctic Cat to cut the key, the dealer needs to order a Key (p/n 0409-003). Dealer must then enter the 4-digit key code (4000-4299) found on each key.

1998-Present 2-Stroke Snowmobile 2010-Earlier 4-Stroke Snowmobile

■NOTE: If a dealer wants Arctic Cat to cut the key, the dealer needs to order a Key (p/n 0409-003). Dealer must then enter the code (ex: A79620).

■NOTE: Each key code is stamped and/or is molded into the head of the key (example: Electric start snowmobile keys with a "1A" code order p/n 0609-453). If a key has been lost, the code is also located on the front side of the ignition switch.

1998-Present 2-Stroke Models			
Electric Start Models		Non-Electric Start Models	
p/n	Key Series	p/n	Key Series
0609-453	1A	0609-349	1A
0609-454	1B	0609-350	1B
0609-455	1C	0609-351	1C
0609-456	1D	0609-352	1D
0609-457	1E	0609-353	1E
0609-458	1F	0609-354	1F
0609-459	2A	0609-355	2A
0609-460	2B	0609-356	2B
0609-461	2C	0609-357	2C
0609-462	2D	0609-358	2D
0609-463	2E	0609-359	2E
0609-464	2F	0609-360	2F

2-Stroke and 4-Stroke through 2006 (Closed Ignitions)	
p/n	Key Series
0609-412	A
0609-467	B
0609-468	C
0609-469	D
0609-470	E

2007-2009 4-Stroke Models	
p/n	Key Series
0409-059	A
0409-060	B

Sizing Charts

Adult Helmets*

Helmet Size	Head-Hat Size	Head Circumference (in.)	Head Circumference (cm)
2XS	6 1/2-6 5/8	20 1/2-20 7/8	52-53
XS	6 3/4-6 7/8	21 1/4-21 5/8	54-55
Small	7-7 1/8	22-22 1/2	56-57
Medium	7 1/4-7 3/8	22 3/4-23 1/4	58-59
Large	7 1/2-7 5/8	23 5/8-24	60-61
XL	7 3/4-7 7/8	24 1/2-24 7/8	62-63
2XL	8-8 1/4	25 1/8-25 1/2	64-65
3XL	8 3/8-8 1/2	26-26 3/8	66-67
4XL	8 1/2-8 5/8	26 3/4-27 1/8	68-69

■NOTE: MX SnoCross helmets run about one size smaller on average than the regular shield helmets (i.e. MX SnoCross Large = Shield Helmet Medium).

Youth Helmets

Helmet Size	Head-Hat Size	Head Circumference (in.)	Head Circumference (cm)
Medium	6 1/8 - 6 1/4	19 - 20	48 - 49
Large	6 3/8 - 6 1/2	20 - 21 1/2	50 - 51

■NOTE: This is a guideline only. Head shape can vary size.

■NOTE: Sizing charts should be used as general guides for determining approximate size. Differences in individual body shape, as well as the type of cut and style of each garment, should be considered to ensure appropriate fit. Please visit your local Authorized Arcticwear Dealer to try on your selection.

Men's Outerwear

Size	Chest	Waist	Inseam
S	36" - 38"	28" - 30"	31"
M	40" - 42"	32" - 34"	31"
MT	40" - 42"	32" - 34"	34"
L	44" - 46"	36" - 40"	32"
LT	44" - 46"	36" - 40"	35"
XL	48" - 50"	42" - 44"	33"
XLT	48" - 50"	42" - 44"	36"
2XL	52" - 54"	46" - 48"	33"
2XLT	52" - 54"	46" - 48"	36"
3XL	56" - 58"	50" - 52"	33"
3XLT	56" - 58"	50" - 52"	36"
4XL	60" - 62"	54" - 56"	33"
5XL	64" - 66"	58" - 60"	33"

■NOTE: 5' 11" and taller, use tall sizes.

Women's Outerwear

Size	Chest	Waist	Hips	Inseam
XS	26" - 30"	19" - 23"	30" - 34"	31"
S	30" - 34"	23" - 26"	34" - 37"	31"
M	34" - 37"	26" - 30"	37" - 40"	31"
MT	34" - 37"	26" - 30"	37" - 40"	33"
L	37" - 40"	30" - 34"	40" - 43"	31"
LT	37" - 40"	30" - 34"	40" - 43"	33"
XL	40" - 43"	34" - 38"	43" - 46"	31"
XLT	40" - 43"	34" - 38"	43" - 46"	33"
2XL	43" - 46"	38" - 41"	46" - 49"	31"
3XL	46" - 49"	41" - 45"	49" - 52"	31"
4XL	49" - 52"	45" - 49"	52" - 55"	31"

■NOTE: 5' 8" and taller, use tall sizes.

Youth Outerwear

Size	Height	Chest	Waist	Inseam
4	45" - 47"	23" - 25"	20" - 22"	17"
6	47" - 49"	25" - 26"	22" - 23"	19"
8	49" - 50"	26" - 27"	23" - 24"	21"
10	51" - 54"	27" - 28"	24" - 25"	23"
12	55" - 58"	29" - 30"	25" - 26"	25"
14	59" - 61"	30" - 32"	26" - 27"	26"
16	62" - 64"	32" - 33"	27" - 28"	27"

One-Piece

Size	Height	Chest	Waist	Inseam
2	33" - 35"	21" - 22"	19" - 20"	16"
3	36" - 38"	22" - 23"	20" - 21"	17"
4	39" - 41"	23" - 24"	21"	18"
5	42" - 44"	24" - 25"	21" - 22"	19"
6	45" - 46"	25" - 26"	22"	20"
7	47" - 49"	26" - 27"	22" - 23"	21"

Glossary

Missy/Womens - Missy sizes, also referred to as straight sizes, are the sizes most commonly carried in standard women's clothing stores and generally run from 2 to 18 in even sizes.

Juniors - Juniors sizes are designed for young women ages 13 to 18 and are usually cut slimmer in the hips and bust than missy sizes. They're designated by uneven sizes 0 to 17.

Arcticwear Size Ratios

Jackets and Pants												
	S	M	MT	L	LT	XL	XLT	2XL	2XLT	3XL		
Men's	2%	10%	2%	28%	6%	30%	8%	10%	2%	2%		
Women's	12%	33%	2%	32%	2%	16%	1%	2%				
	4	6	8	10	12	14	16					
Youth	4%	10%	18%	20%	20%	15%	13%					
	2	3	4	5	6	7						
Youth One Piece Suits	10%	14%	17%	22%	19%	18%						
Boots												
	6	7	8	9	10	11	12	13				
Men's		5%	8%	18%	25%	23%	15%	6%				
Women's	10%	23%	35%	22%	10%							
Youth Boots	8	9	10	11	12	13	1	2	3	4	5	6
Children's	7%	8%	11%	14%	15%	15%	15%	15%				
Boy's									18%	18%	26%	38%
Helmets												
	2XS	XS	S	M	L	XL	2XL	3XL				
TXi / PFP	2%	2%	11%	24%	30%	19%	9%	3%				
MX			4%	15%	41%	30%	10%					
Youth				42%	58%							
Gloves												
	XS	S	M	L	XL	2XL	3XL					
Adult	2%	6%	17%	32%	30%	11%	2%					
Youth		15%	30%	35%	20%							
Sportswear												
	S	M	L	XL	2XL							
Adult Shirts	5%	15%	35%	30%	15%							
	6-8	10-12	14-16									
Youth Shirts	27%	33%	40%									

Accessory Bag Dimensions

Ref	p/n	Description		Length	Width/Depth	Height
90	5639-618	Tunnel Pack		15"	12"	4"
90	5639-573	Tunnel Pack		13"	13"	7"
90	5639-433	Tunnel Pack		24"	15"	6"
90	5639-707	Tunnel Gear Bag		22"	12"	7"
90	5639-574	Tunnel Gear Bag		20"	12"	8"
90	5606-171	Touring Gear Bag		19"	13"	9"
90	4639-712	Touring Saddlebags		22"	7"	12"
91	5639-712	Windshield Bag		9"	14"	4"
91	4639-714	Windshield Bag		23"	10"	6"
91	5639-304	Windshield Bag		24"	12"	6"
91	4639-428	Windshield Bag		26"	3"	5"
91	5639-708	Handlebar Bag		7"	10"	5"
91	5639-709	Handlebar Bag		7"	10"	8"
91	4639-429	Handlebar Bag		9"	6"	7"
91	5639-303	Handlebar Bag		6"	11"	8"
91	5639-434	Handlebar Bag		6"	7"	7"
91	5639-041	Custom Handlebar Bag		8"	4"	6"
109	5639-710	Mountain Pack		9"	14"	6"
109	5639-711	Mountain Gear Bag		18"	14"	8"
109	5639-043	Mountain Seat Bag		12"	16"	9"
110	5639-767	Goggle Holder		9"	6"	4"
110	4639-732	Goggle Holder		10"	3"	6"
118	5639-049	Bearcat Gear Bag		31"	17"	15"
118	6606-252	Tunnel Pack		14"	17"	10"
16	3639-715	Windshield Bag		38"	5"	7"
16	3639-962	Windshield Bag		13"	3"	7"
18	4639-445	LXR Saddlebags		20"	6"	11"
18	5639-301	Seat Pack	Main	9"	13"	8"
18	4639-715	Custom Saddlebags		14"	4"	12"
18	4639-426	Tank Bag		13"	9"	10"
18	5639-305	Underhood Bag		9"	21"	9"
19	4639-427	Windshield Flair Bags		4"	11"	3"
19	3639-722	Firecat Trunk Bag		10"	14"	7"
34	5639-044	Mountain Gear Bag		14"	20"	9"
34	3639-725	Mountain Pack		9"	12"	7"
34	4639-727	Mountain Gear Bag	Main	17"	16"	8"
			Side	10"	4"	7"

Kit Installation Times

p/n	Description	Application	Labor (mins)
5639-347	Tunnel Rails (Pair)	'10-'11 F Series, Z1, Z1 Turbo; '12 F5, F570	25
5639-348	Tunnel Rails (Pair)	'10-'11 Z1 Turbo EXT; '11 F8 EXT	25
5639-717	2-Up Seat Kit	'12 F 800, F 1100, F 1100 Turbo, XF 800, XF 1100, XF 1100 Turbo	30
5639-307	2-up Seat Kit	'10-'11 F Series, Z1, Z1 Turbo, Z1 Turbo EXT; '11 F8 EXT; '12 F5, F570	20
5639-308	2-up Seat Kit	'09-'11 CF, CFR (Requires Hitch Kit)	15
5639-150	2-up Seat Kit	'09 F Series (Liquid-Cooled), Z1, Z1 Turbo	20
4639-451	2-up Seat Kit	'07-'08 F Series (Liquid-Cooled), JR	60
5639-850, 851, 852	Sport Bumper	'12 F 800, F 1100, M 800, M 800 HCR, M 1100, XF 800, XF 800 HC, XF 1100	10
5639-825, 826, 827	Sport Bumper	'07-'11 F Series; '08-'11 T 570, TZ1 Touring; '09-'11 BC 570, Z1, Z1 Turbo; '12 F5, F570	20
5639-065	Sport Bumper - Green (Aluminum)	'10-'11 Sno Pro 500	15
5639-622, 623, 624	Sport Bumper	'05-'11 M Series; '06-'11 CF; '09-'11 CFR, M8 HCR	20
5639-312	Touring Bumper - Black (Steel)	'07-'11 F Series; '08-'12 T 570, TZ1 Touring; '09-'12 BC 570, Z1 (Non-Turbo)	20
5639-718, 719, 720	Procross Rack	'12 F 800, F 1100, F 1100 Turbo, XF 800, XF 1100, XF 1100 Turbo	15
5639-313, 314, 315	Sport Rack	'10-'11 F Series, Z1, Z1 Turbo, Z1 Turbo EXT; '11 F8 EXT	10
5639-155, 156, 157	Crossfire Rack - Green	'09-'11 CF, CFR (Requires Hitch Kit)	15
5639-316, 317	Touring Rack - Short/Long	'08-'12 T 570, TZ1 Touring; '09-'12 BC 570	20
5639-721	Hitch Kit, Pivot	'12 F 800, F 1100, F 1100 Turbo 128-in.	40
5639-722	Hitch Kit, Pivot	'12 XF 800, XF 1100, XF 1100 Turbo 141-in.	40
5639-723	Hitch Kit, Pivot	'12 M 800, M 800 HCR, M 1100, M 1100 Turbo, XF 800 HC, XF 1100 Turbo HC 153-in.	40
5639-724	Hitch Kit, Pivot	'12 M 800, M 1100 Turbo, M 1100 Turbo HCR 162-in.	40
5639-318	Hitch Kit, Pivot	'10-'11 F Series, Z1, Z1 Turbo 128-in.; '12 F5, F570	30
5639-319	Hitch Kit, Pivot	'10-'11 Z1 Turbo EXT; '11 F8 EXT 144-in.	30
4639-966	Hitch Kit, Pivot	'09 F Series, Z1, Z1 Turbo 128-in.	30
4639-452	Hitch Kit, Pivot	'07-'08 JR; '07-'08 F Series (Liquid-Cooled)	20
5639-158	Hitch Kit, Pivot	'09-'11 M Series, M8 HCR 153-in.	30
5639-159	Hitch Kit, Pivot	'09-'11 M Series 162-in.	30
5639-166	Hitch Kit, Pivot	'09-'11 CF 141-in.	30
5639-202	Hitch Kit, Pivot	'09-'11 CFR 128-in.	30
4639-788	Hitch Kit, Pivot	'06-'08 CF; '07-'08 M Series	25
4639-723	Hitch Kit, Pivot	'08-'12 T 570, TZ1 Touring (Pivot)	25
4639-907	Hitch Kit, Pintle	'08-'12 T 570, TZ1 Touring (Pintle)	25
1639-607	Hitch Kit, Pivot	'00-'05 PTA; '04-'07 T660 Touring	30
1639-507	Hitch Kit, Pivot	'99-'02 PA; '99-'06 121-in. Models; '07 Z, T660 Trail	25
2639-686	Hitch Kit, Pivot	'03-'06 FC; '04-'06 SC 128-in. & 144-in.	25
5639-725	Tow Hitch - Pivot	'12 F 800, F 1100, F 1100 Turbo, M 800, M 800 HCR, M 1100, M 1100 Turbo, M 1100 Turbo HCR, XF 800, XF 1100, XF 1100 Turbo, XF 800 HC, XF 1100 Turbo HC	15
5639-324	Tow Hitch - Pivot	'09-'11 CF, CFR, M Series; '10-'11 F Series, Z1, Z1 Turbo, Z1 Turbo EXT; '11 F8 EXT	25
4639-124	Tow Hitch - Pivot	'05-'08 M Series; '06-'08 CF	25
1639-505	Tow Hitch - Pivot	'99-'06 121-in. Models; '07 Z, T660 Trail	25
3639-189	Pintle Conversion Kit	Fits Pivot Hitch Kits Listed Above	5
5639-531	Remote Start Kit	'08-'12 TZ1 Touring; '09-'12 BC Z1 XT, Z1	60
5639-646	Electric Start Kit	'11 F Series 800	190
5639-321	Electric Start Kit	'10 BC 570	190
5639-198	Electric Start Kit	'09-'11 F Series 800, 1000	190
4639-803	Electric Start Kit	'08-'11 CF, M Series 500, 600	120
4639-782	Electric Start Kit	'08-'11 F Series 500, 600	190
5639-861	Engine Heater (US & Canada)	'12 F 1100, F 1100 Turbo, M 1100, M 1100 Turbo, XF 1100, XF 1100 Turbo, XF 1100 Turbo HC	45
5639-823	Engine Heater (US & Canada)	'07-'12 TZ1; '09-'12 BC Z1 XT, Z1, Z1 Turbo (US & Canada)	45
5639-824	Engine Heater (International)	'07-'12 TZ1; '09-'12 BC Z1 XT, Z1, Z1 Turbo (International)	45
0638-188	Engine Heater	'99-'07 LC Models Except CF, F, FC, JR, M, SC, 4-Stroke	30
5639-731	Fox Float Evol, Ski Shock Kit (Pair)	'12 F 800, F 1100, F 1100 Turbo, XF 800, XF 1100, XF 1100 Turbo (42-in. Stance)	15
5639-732	Fox Float Evol, Ski Shock Kit (Pair)	'12 M 800, M 1100, M 1100 Turbo (40-in. Stance)	15
5639-733	Fox Float R Evol, Ski Shock Kit (Pair)	'12 F 800, F 1100, F 1100 Turbo, XF 800, XF 1100, XF 1100 Turbo (42-in. Stance)	15
5639-734	Fox Float R Evol, Ski Shock Kit (Pair)	'12 M 800, M 1100, M 1100 Turbo, M 1100 Turbo HCR (40-in. Stance)	15
5639-587	Fox Float R Evol, Ski Shock Kit (Pair)	'07-'11 F Series; '09-'11 Z1, Z1 Turbo	15
5639-588	Fox Float R Evol, Ski Shock Kit (Pair)	'05-'11 M Series	15
5639-589	Fox Float R Evol, Ski Shock Kit (Pair)	'06-'11 CF; '09-'11 CFR	15
5639-590	Fox Float R Evol, Ski Shock Kit (Pair)	'10-'11 Sno Pro 500	10
5639-735	Fox Float RC2 Evol, Ski Shock Kit (Pair)	'12 F 800, F 1100, F 1100 Turbo, XF 800, XF 1100, XF 1100 Turbo (42-in. Stance)	15
5639-625	Fox Float RC2 Evol, Ski Shock Kit (Pair)	'10-'11 Sno Pro 500	10
5639-729	Fox Float 2, Ski Shock Kit (Pair)	'12 F 800, F 1100, F 1100 Turbo, XF 800, XF 1100, XF 1100 Turbo (42-in. Stance)	15
5639-730	Fox Float 2, Ski Shock Kit (Pair)	'12 M 800, M 1100, M 1100 Turbo (40-in. Stance)	15
5639-583	Fox Float 2, Ski Shock Kit (Pair)	'07-'11 F Series; '09-'11 Z1, Z1 Turbo	15

Kit Installation Times (cont)

p/n	Description	Application	Labor (mins)
5639-584	Fox Float 2, Ski Shock Kit (Pair)	'05-'11 M Series	15
5639-585	Fox Float 2, Ski Shock Kit (Pair)	'06-'11 CF; '09-'11 CFR	15
5639-586	Fox Float 2, Ski Shock Kit (Pair)	'10-'11 Sno Pro 500	10
5639-750	Fox Float 2, Rear Arm Shock Kit	'12 M 800, M 1100, M 1100 Turbo, XF 800, XF 1100, XF 1100 Turbo; '08-'11 M Series	15
5639-727	Pink Accessory Kit	'12 F 800 LXR, F 1100 LXR - Black	40
5639-728	Pink Accessory Kit	'12 XF 800 LXR, XF 1100 LXR - Black	40
5639-806	Pink Accessory Kit	'12 F570	40
5639-838	Pink Accessory Kit	'12 F5 LXR	60
5639-576	Pink Accessory Kit	'11 F 570	40
5639-607	Pink Accessory Kit	'11 F5 LXR	60
5639-608	Pink Accessory Kit	'11 F8, Z1 LXR	60
5639-745, 746, 747, 748	Skid Plate, Front	'12 F 800, F 1100, M 800, M 800 HCR, M 1100, XF 800, XF 800 HC, XF 1100	10
5639-893, 894, 895, 896	Skid Plate, Rear	'12 F 800, F 1100, F 1100 Turbo, M 800, M 800 HCR, M 1100, M 1100 Turbo, M 1100 Turbo HCR, XF 800, XF 800 HC, XF 1100, XF 1100 Turbo, XF 1100 Turbo HC	40
4639-567, 568, 569	Skid Plate	'07-'11 F Series; '08-'12 T 570, TZ1 Touring; '09-'11 Z1, Z1 Turbo; '10-'11 Z1 Turbo EXT; '11 F8 EXT; '12 F5, F570	30
3639-838, 839	Skid Plate	'05-'11 M Series; '06-'11 CF; '09-'11 CFR, M8 HCR	30
4639-564	Skid Plate	'05-'11 M Series; '06-'11 CF; '09-'11 CFR, M8 HCR	30
5639-582, 223	Skid Plate	'05-'11 M Series; '06-'11 CF; '09-'11 CFR, M8 HCR	30
1639-417	Skid Plate - Black	'00-'06 ZR; '01-'03 ZI; '01-'04 MC; '01-'08 Z; '04-'06 KC	30
5639-328, 329, 330	Grip Plates (Pair)	'10-'11 F Series, Z1, Z1 Turbo, Z1 Turbo EXT; '11 F8 EXT; '12 F5, F570	10
5639-611	Toe Hold (Pair) - Black	'10-'12 Sno Pro 500	20
5639-062	Cargo Rack	'09-'12 BC XT	15
5639-060, 061	Side Rails - Short/Long	'09-'12 BC XT	5
5639-339	Receiver Bumper - Rear	'09-'12 BC XT	30
5639-338	Receiver Bumper - Front	'09-'12 BC XT	40
5639-386	Hitch	'09-'12 BC XT	5
5639-387	Pivot Hitch Conversion	'06-'07 BC Wt; '07 BC 570; '09-'12 BC XT	5
5639-340	Receiver Winch	'09-'12 BC XT	35
5639-457	Transport Mount	'09-'12 BC XT	10
5639-456	Rear Harness	'09-'12 BC XT	60
5639-341	Snow Plow Push Frame	'09-'12 BC XT	25
0436-296	Snow Plow Blade	'09-'12 BC XT	20
5639-389	Backup Light Kit	'09-'12 BC XT	35
4639-970	Passenger Handwarmers	'09-'12 BC Z1 XT	40
4639-802	Passenger Handwarmers	'08-'09 T500	40
5639-254	Ski Skins	'09-'12 BC 570, BC XT (8-in. Saddleless Skis)	15
5639-441	Sway Bar	'09-'12 BC 570 XT; '10-'12 BC Z1 XT	25
5639-200	Sway Bar Kit	'09-'12 BC 570	25
4639-322	Sway Bar Kit	'99-'07 PA, Z; '06-'08 BC	25
4639-967	Radiator Kit	'09-'12 BC Z1 XT	90
4639-971	Heated Seat Kit	'09-'11 BC Z1 XT	45
5639-597, 598	Billet Rack	'09-'11 M Series, M8 HCR	10
5639-600, 601, 602	Mountain Seat	'05-'09 M Series; '06-'11 CF; '09-'11 CFR	10
4639-975, 976, 977	M Series Rack	'09-'11 M Series, M8 HCR	10
5639-897	Ice Scratchers	'09-'11 M Series, M8 HCR, CF	10
5639-528	Four Wheel Kit (Adds 2 Inside Wheels)	'09-'11 M Series	25
4639-997	Two Wheel Kit	'08 M Series; '09-'11 CF	20
5639-358	Mountain Strap	'10-'11 Z1 Turbo EXT; '11 F8 EXT	5
5639-360	Long Track Kit	'10-'11 Z1 Turbo EXT; '11 F8 EXT	150
4639-995	Lightweight Front Axle Kit	'05-'08 M Series	60
4639-994	Float Conversion	'05-'07 M Series; '09-'10 CF (Std)	90
5639-107, 108, 109	Tunnel Flares (Pair)	'09-'11 M Series, M8 HCR, CF, CFR	10
5639-580	Switch Guards	'07-'11 M Series; '09-'11 M8 HCR	5
5639-813	Telescopic Steering Post	'12 F 800, XF 800, M 800 (Std)	70
5639-516	Telescopic Steering Post	'09-'11 M Series (Std), CF (Std)	40
5639-858	DC Power Kit	'12 F 800, M 800, XF 800, XF 800 HC	20
5639-258	DC Power Kit	'09-'11 CF, CFR, M Series 800, 1000	25

■NOTE: The above information is intended for use as a guideline when quoting installation time for customers. Variables may cause installation time to be higher or lower. The times listed are not labor rates to be reimbursed to dealers.

Covers



PREMIUM COVERS

Application	p/n
(A) '12-'13 F 800, F 1100 (Inc Turbo) - Green	6639-002
(A) '12-'13 F 800, F 1100 (Inc Turbo) - Orange	6639-003
(A) '12-'13 XF 800, XF 1100 (Inc Turbo) - Green	6639-004
(A) '12-'13 XF 800, XF 1100 (Inc Turbo) - Orange	6639-005
(A) '12-'13 M 800, M 1100, XF HC (Inc Turbo) - Green	6639-006
(A) '12-'13 M 800, M 1100, XF HC (Inc Turbo) - Orange	6639-007
(B) '12-'13 F5, F570; '07-'11 F Series; '09-'11 Z1, Z1 Turbo	6639-008
(B) '08-'13 T570, TZ1, TZ1 LXR Touring; '09-'13 Bearcat 570	6639-009
(C) '12-'13 F 800, F 1100 (Inc Turbo)	6639-010
(C) '12-'13 XF 800, XF 1100 (Inc Turbo)	6639-011
(C) '12-'13 M 800, M 1100, XF HC (Inc Turbo)	6639-012

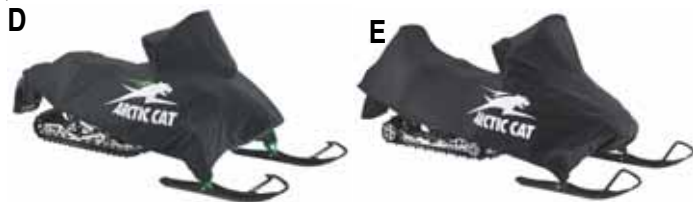

ARCTIC CAT CANVAS COVERS

Application	p/n
(D) '12-'13 F5, F570; '07-'11 F Series; '09-'11 Z1, Z1 Turbo	6639-013
(D) '12-'13 F 800, F 1100 (Inc Turbo)	6639-014
(D) '12-'13 F 800, F 1100 (Inc Turbo) W/2-Up Seat	6639-015
(D) '12-'13 XF 800, XF 1100 (Inc Turbo)	6639-016
(D) '12-'13 XF 800, XF 1100 (Inc Turbo) W/2-Up Seat	6639-017
(D) '12-'13 M 800, M 1100, XF HX (Inc Turbo)	6639-018
(D) '00-'13 120	6639-021
(E) '08-'13 T570, TZ1, TZ1 LXR Touring; '09-'13 Bearcat 570	6639-019
(E) '09-'13 Bearcat 570 XT, Bearcat Z1 ZT; '12-'13 Bearcat Z1 XT GS	6639-020



TEAM ARCTIC CANVAS COVERS

Application	p/n
'12-'13 F 800, F 1100 (inc Turbo)	6639-042
'10-'13 Sno Pro 500	6639-043



CUSTOM COVERS (NON-CURRENT)

Application	p/n
'03-'06 128" Firecat, Sabercat	5639-017
'99-'06 121" Cougar, EXT, T660, Thundercat, Z, ZL, ZR, ZRT	5639-018
'05-'08 M Series M Series 153"-162"	5639-241
'02-'04 Mountain King Cat, Mountain Cat, Powder Special	5639-019
'00-'06 2-Up Touring Panther, Pantera, T660 Touring	5639-020
'03-'08 Bearcat W/T Bearcat W/T	5639-021
'06-'11; '06-'07 M Series 141" Crossfire; M Series	6639-044
'09-'11 Crossfire	6639-045
'06-'11 2-Up Crossfire Crossfire	5639-283
'07-'12 F-Series w/2-Up Seat '12 F5, F570; '07-'11 F Series; '09-'11 Z1, Z1 Turbo	5639-286
'10-'11 Z1; '11 F8 Z1 Turbo EXT; F8 EXT	5639-547



Page 88

DUST COVER

Application

121-in.-128-in.
136-in.-162-in. Mountain
2-Up Touring

p/n

5639-705
5639-706
5639-716



Page 88

UNDERCOVER LINER

Application

Universal

p/n

5639-570



REPLACEMENT COVER STRAPS

Description

(A) Sew-On Straps w/Buckles (Pkg 4)
(B) Cinch Straps w/Hook (Pkg 4)

p/n

0636-610
0636-527

Touring Bags

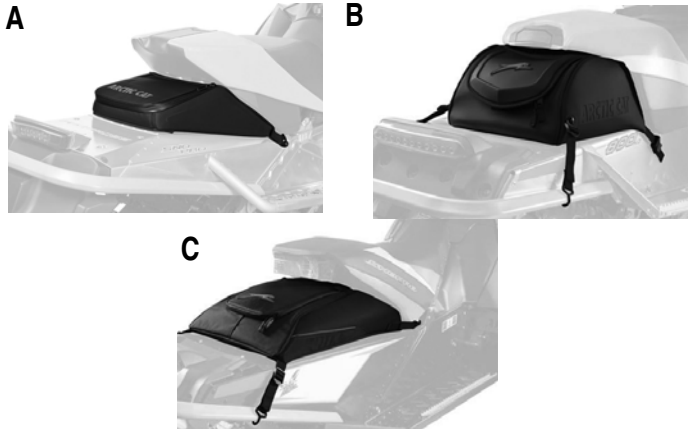

Page 90

TUNNEL PACK

Application	p/n
(A) '12 F 800, F 1100, F 1100 Turbo, M 800, M 800 HCR, M 1100, M 1100 Turbo, M 1100 Turbo HCR, XF 800, XF 1100, XF 1100 Turbo, XF 800 HC, XF 1100 Turbo HC	5639-618
(B) '12 F5, F570; '07-'11 F Series; '10-'11 Z1, Z1 Turbo, Z1 Turbo EXT; '11 F8 EXT	5639-573
(C) '10-'12 Sno Pro 500, '10-'11 M Series	5639-433
Replacement Strap w/Hook (Pkg/4)	0641-994
Replacement Spool (Pair)	6639-154
Replacement Clips (Pair)	6639-155

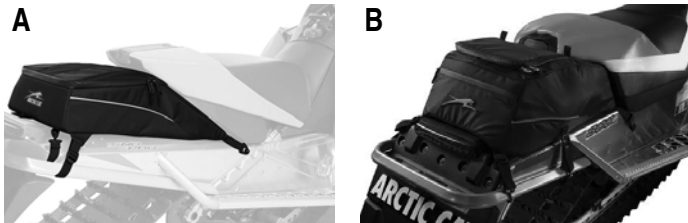

Page 90

TUNNEL GEAR BAG

Application	p/n
(A) '12 F 800, F 1100, F 1100 Turbo, XF 800, XF 1100, XF 1100 Turbo	5639-707
(B) '12 F5, F570; '10-'11 F Series, M Series, Z1, Z1 Turbo, Z1 Turbo EXT; '11 F8 EXT	5639-574
Replacement Strap w/Hook (Pkg/4)	0641-994
Replacement Cam Buckles (Pkg/2)	0639-089
Replacement Clips (Pair)	6639-155

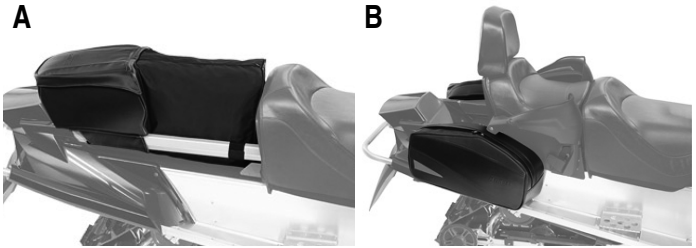

Page 90

A. TOURING GEAR BAG

Application	p/n
'08-'12 T 570, TZ1 Touring; '09-'12 BC 570	5606-171

B. TOURING SADDLEBAGS

Application	p/n
'08-'12 T 570, TZ1 Touring; '09-'12 BC 570	4639-712



p/n 4639-714



p/n 3639-962

p/n 3639-715



p/n 4639-428



Page 91

WINDSHIELD BAG

Not recommended for fan-cooled machines.

Application	p/n
'12 F 800, F 1100, F 1100 Turbo, M 800, M 800 HCR, M 1100, M 1100 Turbo, M 1100 Turbo HCR, XF 800, XF 1100, XF 1100 Turbo, XF 800 HC, XF 1100 Turbo HC	5639-712
'12 F5, F570; '08-'11 F Series, TZ1 Touring; '09-'12 BC; '09-'11 Z1	4639-714
'09-'11 Z1 Turbo, TZ1 Turbo Touring	5639-304
'05-'11 M Series; '06-'11 CF; '09-'11 CFR, M8 HCR	4639-428
'03-'06 FC; '04-'06 SC	3639-715
'00-'06 ZR; '01-'04 MC 600, 800, 900; '02-'05 PTA; '04-'06 KC; '03-'07 BC WT (Non-Turbo) - Center Bag Only	3639-962

p/n 5639-708



p/n 5639-709



p/n 5639-434



Page 91

HANDLEBAR BAG

Application	p/n
'12 F 800, F 1100, F 1100 Turbo, M 800 (STD), M 1100 (STD), XF 800, XF 1100, XF 1100 Turbo; '12 F570; '10-'11 F Series, Z1 (STD)	5639-708
'12 M 800 SP, M 800 HCR, M 1100 SP, M 1100 Turbo SP, M 1100 Turbo HCR, XF 800 HC, XF 1100 Turbo HC; '09-'12 BC 570, BC XT; '05-'11 M Series; '06-'11 CF	5639-709
'10-'12 Sno Pro 500	5639-434

Page 91

BAG HEATER KIT

Application	p/n
Fits Handlebar Bags 5639-708, 5639-709	5639-837



Page 91

CUSTOM HANDLEBAR BAG

Application	p/n
Universal	5639-041



Page 92

SPORT MUFFS

Application	p/n
'12 F 800, F 1100, F 1100 Turbo, M 800, M 800 HCR, M 1100, M 1100 Turbo, M 1100 Turbo HCR, XF 800, XF 1100, XF 1100 Turbo	5639-714
'07-'11 Models	5639-524



Page 92

HANDLEBAR MUFFS

Application	p/n
Universal	5639-713



Page 92

PASSENGER HAND MUFFS

Application	p/n
'08-'12 T 570, TZ1 Touring; '09-'12 BC 570, BC XT	5639-353



LXR SADDLEBAGS

Application	p/n
'07-'09 F Series; '09 Z1	4639-445
Replacement Cam Buckles (Pkg/2)	1639-248



SEAT PACK

Application p/n
 '12 F5, F570; '07-'11 F Series, Z1, Z1 Turbo, Z1 Turbo EXT; '11 F8 EXT 5639-301
 (Fixed or Adjustable Seat)



TANK BAG

Application p/n
 '12 F5, F570; '07-'11 F Series; '08-'11 T 570, TZ1 Touring;
 '09-'11 BC 570, Z1, Z1 Turbo 4639-426



UNDERHOOD BAG

Application p/n
 '09-'11 TZ1 Touring, Z1 (Non-Turbo) 5639-305



WINDSHIELD FLAIR BAGS

Sold as a pair.

Application p/n
 '00-'06 ZR; '01-'04 MC; '01-'07 Z; '02-'05 PTA;
 '04-'06 KC; '03-'08 BC 570, PA 4639-427



FIRECAT TRUNK BAG

Application p/n
 '03-'06 FC 128" 3639-722
 Replacement Cam Buckles 1639-248

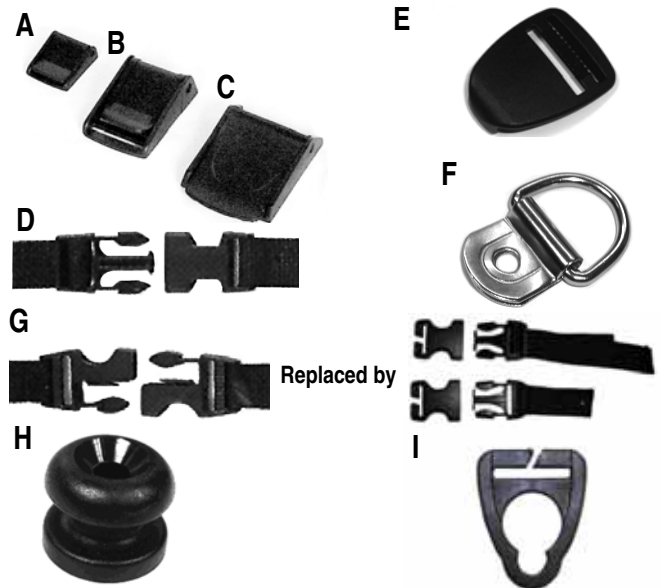

REPLACEMENT HARDWARE

Description	p/n
(A) Cam Buckle (Pair) - 1"	0639-089
(B) Cam Buckle (Pair) - 1-1/2"	1639-248
(C) Cam Buckle (Pair) - 2"	2639-152
(D) SR1 Buckle Kit (Pair)	0638-082
(E) Strap Hook (Pair)	0641-485
(F) Tunnel Clip - Black (Each)	6606-244
(G) Buckle Kit - Unisex Replacement (Pair)	2639-662
(H) Spool (Pair)	6639-154
(I) Clip (Pair)	6639-155

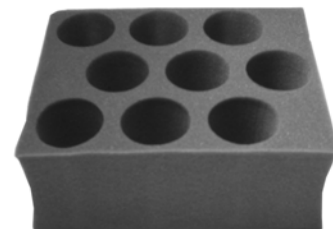

FOAM BEVERAGE HOLDER

Description p/n
 Foam Beverage Holder 11" x 9" x 4" 1639-599

Touring Accessories



Page 93

TUNNEL RAILS

Includes mounting pockets for 2-Up seat and rack.

Application	p/n
'12 F5, F570; '10-'11 F Series, Z1, Z1 Turbo	5639-347
'10-'11 Z1 Turbo EXT; '11 F8 EXT	5639-348

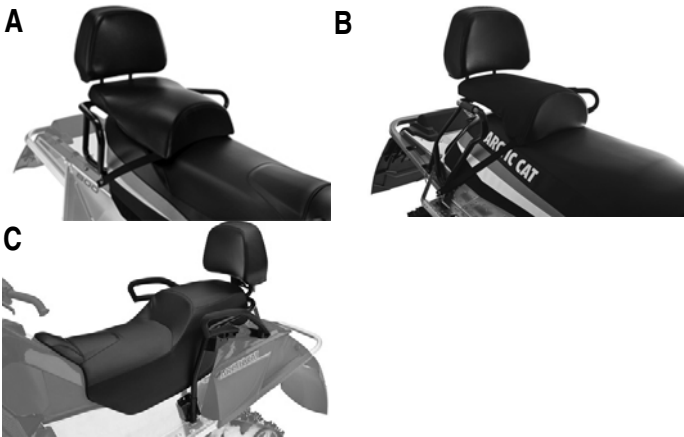

Page 93

2-UP SEAT KIT

Application	p/n
'12 F 800, F 1100, F 1100 Turbo, XF 800, XF 1100, XF 1100 Turbo (Requires Hitch Kit with mounting pockets)	5639-717
(A)'12 F5, F570; '10-'11 F Series, Z1, Z1 Turbo, Z1 Turbo EXT; '11 F8 EXT (Requires Tunnel Rails)	5639-307
(B)'09-'11 CF, CFR (Requires Hitch Kit with mounting pockets) - will accept rear rack or rear bag	5639-308
(C)'09 F Series (Liquid-Cooled), Z1, Z1 Turbo	5639-150
(C)'07-'08 F Series (Liquid-Cooled), JR	4639-451

REPLACEMENT PIN

Description	p/n
Pin w/Clip (Each)	0441-555

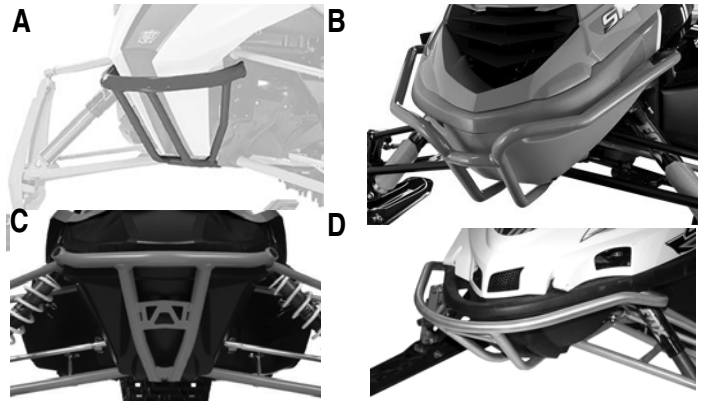

Page 94

SPORT BUMPER - ALUMINUM

Application	Color	p/n
(A)'12 F 800, F 1100, M 800, M 800 HCR, M 1100, XF 800, XF 800 HC, XF 1100	Black	5639-850
	Green	5639-851
	Orange	5639-852
	White	1707-551
(B)'12 F5, F570; '07-'11 F Series; '08-'12 T570, TZ1 Touring; '09-'12 BC 570; '09-'11 Z1, Z1 Turbo	Black	5639-825
	Green	5639-826
	Orange	5639-827
(C)'10-'12 Sno Pro 500	Green	5639-065
(D)'05-'11 M SERIES; '06-'11 CF; '09-'11 CFR, M8 HCR	Black	5639-622
	Green	5639-623
	Orange	5639-624



Page 94

TOURING BUMPER - STEEL

Top tube interferes with hood removal on turbo models.

Application	Color	p/n
'12 F5, F570; '07-'11 F Series; '08-'12 T570, TZ1 Touring; '09-'12 BC 570; '09-'11 Z1 (Non-Turbo)	Black	5639-312

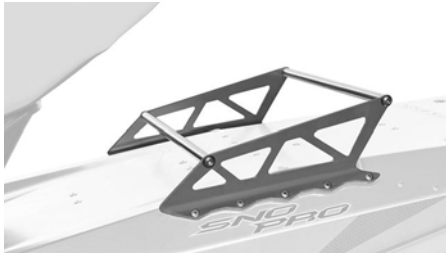

Page 94

PROXCROSS RACK

8" x 11½" W

Application

'12 F 800, F 1100, F 1100 Turbo, XF 800, XF 1100, XF 1100 Turbo

Color

Green 5639-718
Orange 5639-719
Silver 5639-720

p/n

■NOTE: XF High Country models require Proclimb Rack shown on page 33.



Page 94

CROSSFIRE RACK

Requires Hitch Kit with mounting pockets.

Application

'09-'11 CF, CFR

Color

Unpainted

p/n

5639-157



Page 94

SPORT RACK

Mounts directly to the tunnel, or quick-attach to Tunnel Rails.

Application

'12 F5, F570; '10-'11 F Series; '10-'11 Z1, Z1 Turbo, Z1 Turbo EXT; '11 F8 EXT

Color

Unpainted

p/n

5639-315



Page 95

TOURING RACK

Application

'08-'12 T570, TZ1 Touring; '09-'12 BC 570

Style

(A) Short 5639-316
(B) Long 5639-317

p/n



Page 95

HITCH KITS - PIVOT STYLE

Application

'12 F 800, F 1100, F 1100 Turbo 128" (Includes Mounting Pockets for 2-Up Seat) 5639-721
'12 XF 800, XF 1100, XF 1100 Turbo 141" (Includes Mounting Pockets for 2-Up Seat) 5639-722
'12 M 800, M 800 HCR, M 1100, M 1100 Turbo, XF 800 HC, XF 1100 Turbo HC 153" 5639-723
'12 M 800, M 1100 Turbo, M 1100 Turbo HCR 162" 5639-724
'12 F5, F570; '10-'11 F Series, Z1, Z1 Turbo 128" 5639-318
'10-'11 Z1 Turbo EXT; '11 F8 EXT 144" 5639-319
'09 F Series, Z1, Z1 Turbo 128" 4639-966
'09-'11 M Series; '10 M8 HCR 153" 5639-158
'09-'11 M Series 162"; '11 M8 HCR 153" 5639-159
'09-'11 CF 141" (Includes Mounting Pockets for 2-Up Seat and Rack) 5639-166
'09-'11 CFR 128" (Includes Mounting Pockets for 2-Up Seat and Rack) 5639-202
'08-'12 T570, TZ1 Touring (Pivot) 4639-723
'08-'12 T570, TZ1 Touring (Pintle) 4639-907
'06-'08 CF; '07-'08 M Series 4639-788
'07-'08 JR; '07-'08 F Series (Liquid-cooled) 4639-452
'03-'06 FC; '04-'06 SC 128" & 144" 2639-686
'00-'05 PTA; '04-'07 T660 Touring 1639-607
'99-'02 PA; '99-'06 121-IN. Models; '07 Z, T660 Trail 1639-507

p/n



Page 95

PINTLE CONVERSION KIT

Application

Fits Pivot-Style Hitch Kits

p/n

3639-189

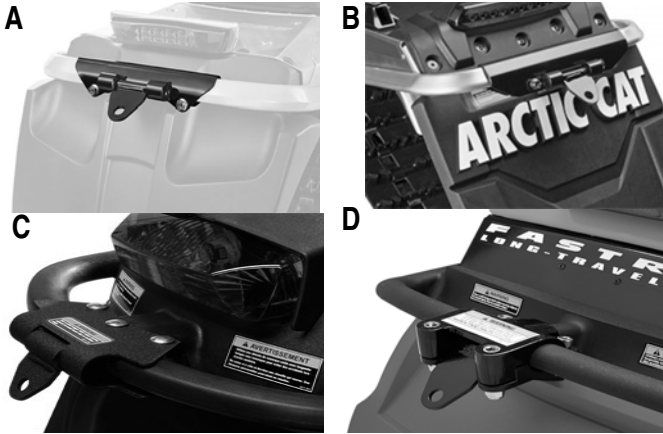

Page 95

TOW HITCH

Application	p/n
(A) '12 F 800, F 1100, F 1100 Turbo, M 800, M 800 HCR, M 1100, M 1100 Turbo, M 1100 Turbo HCR, XF 800, XF 1100, XF 1100 Turbo, XF 800 HC, XF 1100 Turbo HC	5639-725
(B) '12 F5, F570; '10-'11 F Series; '09-'11 CF, CFR, M Series; '10-'11 Z1, Z1 Turbo, Z1 Turbo EXT; '11 F8 EXT	5639-324
(C) '05-'08 M Series; '06-'08 CF	4639-124
(D) '99-'06 121-in. Models; '07 Z, T660 Trail	1639-505



Page 96

TETHER SWITCH

Application	p/n
'12 F 800, M 800, XF 800, XF 800 HC	5639-859
'12 F 1100, F 1100 Turbo, M 1100, M 1100 Turbo, XF 1100, XF 1100 Turbo, XF 1100 Turbo HC	5639-860
'07-'11 F LXR; '07-'12 T570; '09-'12 BC 570	4639-784
'07-'11 F Series Std & Sno Pro; '08-'11 CF, M Series; '09-'11 CFR; '99-'07 Normally Open Circuits	4639-140
'08-'09 TZ1; '09 Z1, BC Z1 XT (inc. Turbo)	4639-785
'10-'11 Z1; '10-'12 TZ1, BC Z1 XT Normally Closed Circuits	5639-523
Replacement Tether Cord	0638-887
	0709-055



Page 96

HEATED SEAT KIT

NOTE: Not available for 2-stroke - power output insufficient.

Application	Year	p/n
F 1100, F 1100 Turbo, XF 1100, XF 1100 Turbo	'12	5639-828
M 1100, M 1100 Turbo	'12	5639-829
BC Z1 XT (Driver & Passenger)	'09-'12	4639-971
BC Z1 XT LTD (Passenger)	'11-'12	5639-638



Page 96

ELECTRIC START KIT

For replacement parts, see appropriate parts manual.

Application	p/n
'10 BC 570	5639-321
'08-'11 CF, M Series 500, 600	4639-803
'08-'11 F Series 500, 600	4639-782
'11 F Series 800	5639-646
'09-'10 F Series 800, 1000	5639-198



DC POWER KIT

Application	Year	p/n
F 800, M 800, XF 800	'12	5639-858
CF, CFR, M Series 800/1000	'09-'11	5639-258



ENGINE HEATER

Application	p/n
'12 F 1100, F 1100 Turbo, M 1100, M 1100 Turbo, XF 1100, XF 1100 Turbo, XF 1100 Turbo HC	5639-861
'07-'12 TZ1; '09-'12 BC Z1 XT, TZ1 Turbo; '07-'11 Z1, Z1 Turbo	5639-823
'99-'07 LC Models except CF, F, FC, JR, M, SC, 4-Stroke	0638-188

A



B



REMOTE START KIT

Application	p/n
'08-'12 TZ1 Touring; '09-'12 BC Z1 XT, '09-'11 Z1, Z1 Turbo	5639-531
Replacement Transmitter	
(A) 2 Button	0630-146
(B) 3 Button	0630-187

Replacement Battery A23S 12V (purchase locally)

■ **NOTE: For programming instructions, please visit [Cat Tracker Online](#).**

BATTERIES

Application	Year	p/n
BC 570	'09-'12	0745-047
	'04-'08	0745-059
BC 570 XT	'09-'12	0745-047
BC Z1 XT	'09-'12	0645-480
CF 500	'07-'09	0645-480
CF 600	'06-'11	0645-480
F5	'07-'12	0745-047
F570	'08-'12	0745-047
F6	'07-'11	0745-047
F8, F 1000	'07-'11	0645-480
F 1100, F 1100 Turbo	'12	0645-480
M 1100, M 1100 Turbo	'12	0645-480
M6	'05-'11	0645-480
T500	'08-'09	0745-047
T570	'08-'12	0745-047
TZ1 Touring	'08-'12	0645-480
TZ1 Turbo Touring	'09-'12	0645-480
XF 1100, XF 1100 Turbo	'12	0645-480
Z1, Z1 Turbo	'09-'11	0645-480

Windscreens

Page 99

	'12 F 800, F 1100, M 800, M 1100, XF 800, XF 1100 (Inc Turbo)			'12 F5, F570; '07-'11 F Series; '09-'11 Z1; '09-'12 Bearcat, TZ1			'05-'11 M Series; '06-'11 CF; '09-'11 CFR, M8 HCR		
Extreme Low	p/n	Height	Width	p/n	Height	Width	p/n	Height	Width
Black	5639-790	8"	15 1/2"				5639-525		
White	5639-791	8"	15 1/2"				5639-526		
Flyscreens									
Black	5639-794	11"	15 1/2"				5639-140	12"	25 1/2"
Green	5639-792	11"	15 1/2"				5639-138	12"	25 1/2"
Orange	5639-793	11"	15 1/2"				5639-139	12"	25 1/2"
Windscreens									
Low, Black	5639-797	13"	20"	5639-130	7 1/2"	29"	5639-136	14 1/2"	27 3/4"
Low, Green	5639-795	13"	20"	5639-128	7 1/2"	29"	5639-134	14 1/2"	27 3/4"
Low, Orange	5639-796	13"	20"	5639-129	7 1/2"	29"	5639-135	14 1/2"	27 3/4"
Low, Pink	5639-798	13"	20"						

Side Deflectors (Pair) 5639-785 Fits Low Windscreens 5639-795, 5639-796, 5639-797, 5639-798 (Width 25")

Windshields									
Low, Tint				5606-960	8 1/2"	29"			
Mid, Tint	5639-799**	16"	30"	5639-439	12"	33"	4639-203	16"	29 3/4"
Mid, Clear, Green	5639-916**	16"	30"						
Mid, Clear, Orange	5639-917**	16"	30"						
Mid, Clear, Pink	5639-800**	16"	30"	5639-631	12"	33"			
High, Tint	5639-801**	19"	32"	4639-719	15 1/4"	33"	4639-227	18 1/2"	29 3/4"
Extreme High, Clear				5639-222***	20 1/2"	33"			

Accepts Windshield Mirrors (4639-733) *Extreme High Windshield requires Brace kit (5639-628)

Windshields	'10-'12 Sno Pro 500; '08-'11 Sno Pro 600			'09-'12 TZ1 Turbo; '09-'11 Z1 Turbo			'04-'06 KC; '01-'04 MC500-900; '02-'05 PTA; '01-'08 PA; '01-'07 Z; '01-'03 ZL; '00-'06 ZR		
Low, Black				5639-142*	10"	31"			
Low, Green				5639-465*	10"	31"	5639-221	12"	32"
Mid, Tint	5639-615	13"	32"	5606-669*	10"	31"	2606-471	14 1/2"	31 1/2"
High, Tint	5639-500	16"	32"	5639-154**	15"	31"	2606-163	16"	33"

*Turbo Low/Mid Windshield requires Brace Kit (5639-518) **Turbo High Windshield requires Brace Kit (5639-455)

Windshields	'03-'06 FC, SC			'99-'01 600 Touring, PTA; '99-'02 MC 1000; '99-'02 TC, ZRT			'98-'00 PS, Z, ZL; '98-'99 ZR		
Low, Green	5639-220	11 3/4"	32 3/4"						
Low, Tint							1606-818	12 1/4"	30 1/4"
Mid, Tint	3606-943	13 3/4"	31 3/4"	1606-323	14"	31"	1606-074	15 3/4"	28"
High, Tint				1606-541	17 1/2"	31"			

Windshields	'06-'08 BC WT Turbo; '04-'07 T660		
High, Tint	3639-906	20"	33"

Production Windshields	'12 F, M, XF		
Sno Pro, Black	6606-376	8 1/2"	20"
Mountain, Black	6606-134	13 1/2"	25 1/2"
LXR, Tint	6606-377	16 1/2"	27 1/2"
'12 Sno Pro 600			
SnoCross	6606-396		
Cross Country	6606-134		

■NOTE: If replacing the adjustable windshield on '07 F Series and JR, Windshield Mounting Kit (p/n 4639-735) is required.

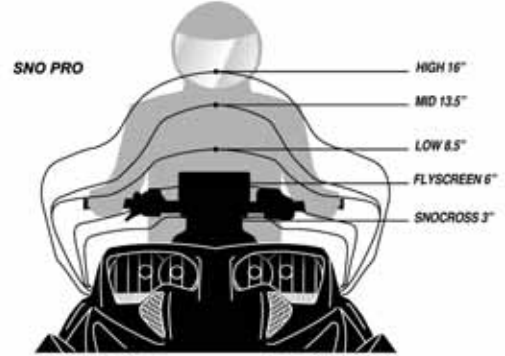
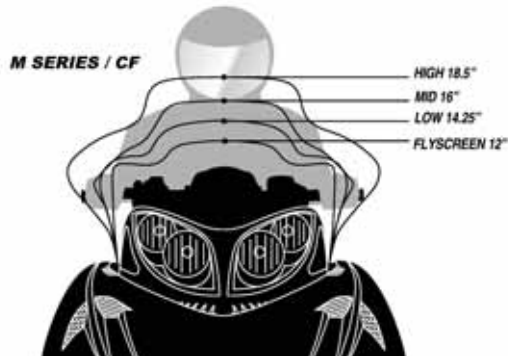
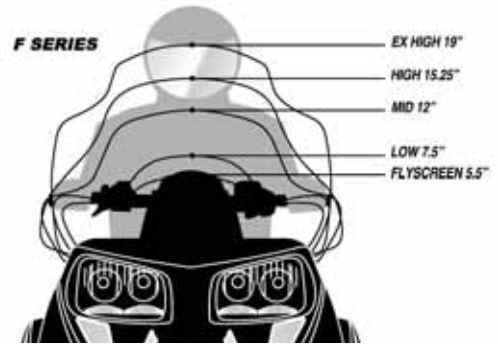
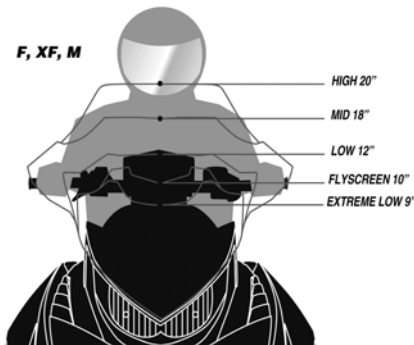

Measurements are taken vertically from dash panel to top of windshield. Style illustrations apply to indicated models only. Use reference point to determine style of windshield to order. Style of windshield for all other models is determined by measuring upward from lowest front center point on windshield to top center point. Accessory windshields do not have pre-drilled mirror mounting holes.



Page 99

A. WINDSHIELD BRACE KIT

Application

Turbo Low/Mid Windshield (5606-669, 5639-142, 5639-465)
 Turbo High Windshield (5639-154)
 Extreme High Windshield (5639-222)

p/n

5639-518
 5639-455
 5639-628

B. WINDSHIELD MOUNTING RING

Description

Universal (Each)

p/n

2606-853

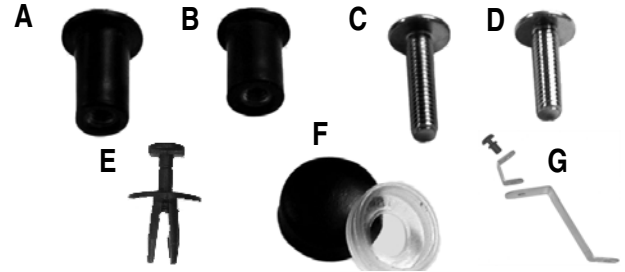

WINDSHIELD HARDWARE

Description

(A) Expansion Nut 10-32 Long
 (B) Expansion Nut 10-32 Short
 (C) Screw 10-32 x 3/4
 (D) Screw 10-32 x 5/8
 (E) Rivet, Plastic
 (F) Snap Cap w/Washer
 (G) Mounting Kit - Required when replacing adjustable windshield on '07 F Series and JR

p/n

0123-010
 0623-845
 1623-764
 0623-121
 0623-902
 8477-516
 0623-362
 0124-054
 4639-735



Page 98

SIDE DEFLECTORS

Fits low windescreens 5639-795, 5639-796, 5639-797, 5639-798

Description

Side Deflectors -Black (Pair)

p/n

5639-785

Custom Accessories

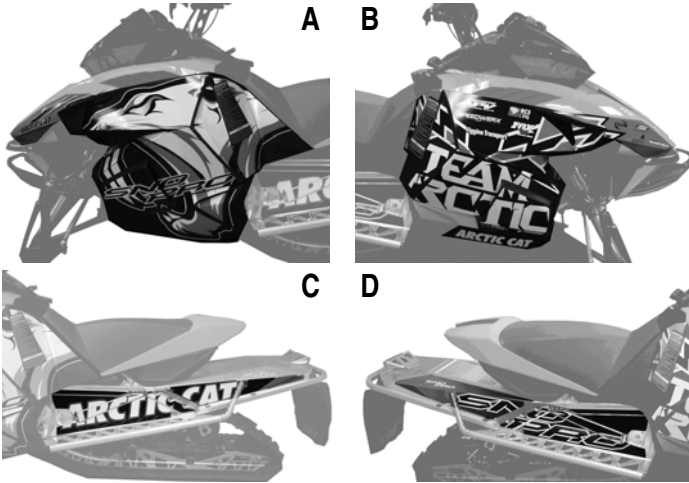

GRAPHIC KITS

Bold, new graphics are available in two styles. Hood and Tunnel kits sold separately. Includes RH & LH Graphics. Fits all '12 F, M, and XF models.

Hood Graphics

	p/n
(A) Sabertooth - Green	5639-918
(A) Sabertooth - Orange	5639-919
(B) Team Arctic - Green	5639-920
(B) Team Arctic - Orange	5639-921

Tunnel Graphics

	p/n
(C) Arctic Cat - Green	5639-922
(C) Arctic Cat - Orange	5639-923
(D) Sno Pro - Green	5639-928
(D) Sno Pro - Orange	5639-929



Page 100

PINK ACCESSORY KITS

Application

	p/n
'12 F 800 LXR, F 1100 LXR (Black)	5639-727
'12 XF 800 LXR, XF 1100 LXR (Black)	5639-728
'12 F570	5639-806
'12 F5 LXR	5639-838



Page 101

A. FOX FLOAT 2

Sold in pairs. Includes pump.

Application

	p/n
'12 F 800, F 1100, F 1100 Turbo, XF 800, XF 1100, XF 1100 Turbo (42" Ski Stance)	5639-729
'12 M 800, M 1100, M 1100 Turbo (40" Ski Stance)	5639-730
'12 F5, F570; '07-'11 F Series; '09-'11 Z1, Z1 Turbo, Z1 Turbo EXT	5639-583
'05-'11 M Series	5639-584
'06-'11 CF; '09-'11 CFR	5639-585

B. FOX FLOAT EVOL

Sold in pairs. Includes pump.

Application

	p/n
'12 F 800, F 1100, F 1100 Turbo, XF 800, XF 1100, XF 1100 Turbo (42" Ski Stance)	5639-731
'12 M 800, M 1100, M 1100 Turbo (40" Ski Stance)	5639-732

C. FOX FLOAT R EVOL

Sold in pairs. Includes pump.

Application

	p/n
'12 F 800, F 1100, F 1100 Turbo, XF 800, XF 1100, XF 1100 Turbo (42" Ski Stance)	5639-733
'12 M 800, M 1100, M 1100 Turbo, M 1100 Turbo HCR (40" Ski Stance)	5639-734
'12 F5, F570; '07-'11 F Series; '09-'11 Z1, Z1 Turbo, Z1 Turbo EXT	5639-587
'05-'11 M Series	5639-588
'06-'11 CF; '09-'11 CFR	5639-589

D. FOX FLOAT RC2 EVOL

Sold in pairs. Includes pump.

Application

	p/n
'12 F 800, F 1100, F 1100 Turbo, XF 800, XF 1100, XF 1100 Turbo (42" Ski Stance) (XC Valving)	5639-735
'10-'12 Sno Pro 500 (XC Valving)	5639-625
'10-'12 Sno Pro 500 (Sno Cross Valving)	0641-250



Page 101

FOX FLOAT 2 REAR ARM

Application	p/n
'12 M 800, M 1100, M 1100 Turbo, XF 800, XF 1100, XF 1100 Turbo; '08-'11 M Series	5639-750



Page 101

AIRSHOX GUARDS

Description	Color	p/n
Fox Float, Float 2, Float Evol, Float R Evol (Pair)	Black	4639-044
	Green	4639-135
	Orange	4639-136

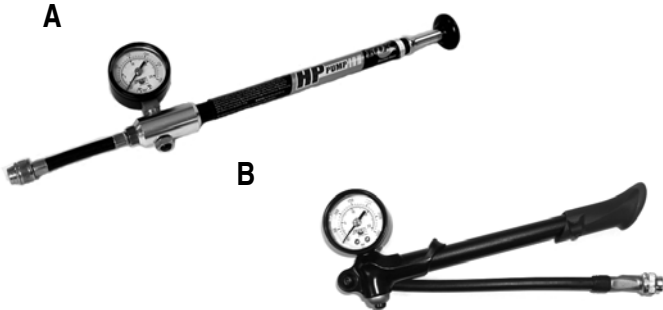

AIRSHOX PUMP

Application	p/n
(A) Replacement Pump - 150 psi (Float, Float 2)	2603-614
(B) Replacement Pump - Dual 100 psi; 300 psi (Float Evol, Float R Evol, Float RC2 Evol)	0641-257



Page 102

SUSPENSION BLOCKS

Application	p/n
Universal	
Black (Pair)	4639-853
Silver (Pair)	4639-855



Page 102

A. RECOIL HANDLE

Description	p/n
Black	5639-452
Silver	5639-454



B. RECOIL HANDLE

Sold individually.

Description	p/n
Black	0636-363
Green	3639-866
Orange	3639-867



Page 102

BRAKE LEVER

Application	p/n
Billet Brake Lever - '12 F 800, F 1100, F 1100 Turbo, M 800, M 800 HCR, M 1100, M 1100 Turbo, M 1100 Turbo HCR, XF 800, XF 1100, XF 1100 Turbo	
Black	5639-736
Silver	5639-737
(A) Sno Pro Lever - '10-'12 Sno Pro 500	
Black	5639-619
Silver	5639-620
(B) Shorty Lever - '12 F5, F570; All '07-'11 Models (Excludes Sno Pro 500)	
Black	5639-505
Silver	5639-506



Page 102

AXLE WASHERS

Application	Color	p/n
'12 F 800, F 1100, F 1100 Turbo, M 800, M 800 HCR, M 1100, M 1100 Turbo, M 1100 Turbo HCR, XF 800, XF 1100, XF 1100 Turbo; '09-'11 M Series, M8 HCR	Black	5639-591
	Silver	5639-592



Page 102

POD SCREWS - PAIR

Application

'12 F5, F570; '07-'11 F Series; '08-'12 T570, TZ1 Touring; '09-'12 BC 570; '09-'11 Z1, Z1 Turbo

Color

Black
Silver

p/n

5639-593
5639-594



Page 103

SNO PRO HAND GUARDS

Sold in pairs. Mounts sold separately. Requires low windshield.

Description

Black
Green
Orange
White

p/n

5639-581
5639-384
5639-261
5639-262

Fits Mounts A, B



Page 103

HAND GUARD EXTENSION

Sold in pairs. Black.

Application

Sno Pro Hand Guards

p/n

5639-263

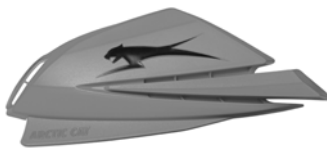

Page 103

ARCTIC CAT HAND GUARDS

Sold in pairs. Mounts sold separately. Requires low windshield.

Description

Black
Green
Orange

p/n

4639-806
4639-807
4639-808

Fits Mounts C, D, E

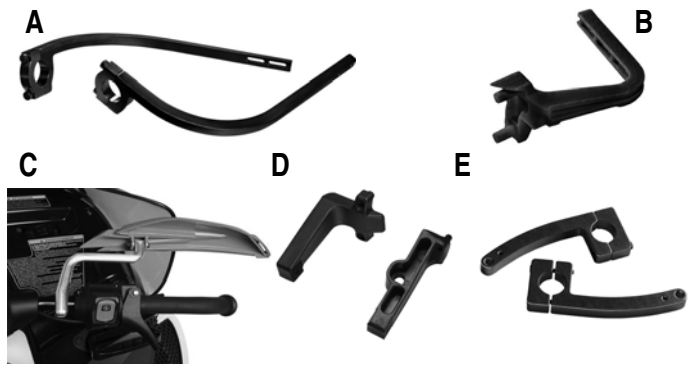

Page 103

HAND GUARD MOUNTS

Sold in pairs.

	'12 F 800, F 1100 (Inc Turbo)	'12 M 800, M 1100, XF 800, XF 1100 (Inc Turbo)	'10-'12 SP 500	'12 F5, F570 '09-'11 CFR '07-'11 F Series '09-'11 Z1, Z1 Turbo
	p/n	p/n	p/n	p/n
(A) Aluminum	5639-264	N/A	5639-264	5639-264
(B) Nylon	5639-763	5639-763	N/A	5639-763
(C) Aluminum	N/A	N/A	4639-805	4639-805
(D) Nylon	N/A	N/A	N/A	4639-804
(E) Aluminum	N/A	N/A	N/A	N/A
	'07-'11 CF '07-'11 M '09-'11 M8 HCR	'06 CF '05-'06 M '00-'02 ZR	'03-'06 FC '03-'06 ZR	
	p/n	p/n	p/n	
(A) Aluminum	N/A	N/A	5639-264	
(B) Nylon	5639-763	N/A	N/A	
(C) Aluminum	N/A	N/A	4639-805	
(D) Nylon	4639-804	3639-077	3639-078	
(E) Aluminum	N/A	N/A	3639-858	

Replacement Hardware

For p/n 4639-804

0641-987

For p/n 5639-264

0641-261

For p/n 5639-385, 5639-763

0641-258



Page 103

HANDLEBAR GRIPS

Two 8-in. black grips. Cut to length.

Description

Black (Pair)

p/n

5639-655

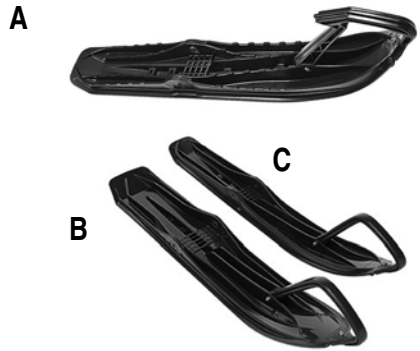

Page 104

ARCTIC CAT SADDLELESS SKIS

Includes 4" carbides. Fits all applications (97 & Newer Models) except cast-aluminum spindle (see Universal Plastic Skis). Sold in pairs.

Description	p/n
(A) 6" Ski Kit (Standard Keel) - Mountain Ski	5639-877
(A) 6" Ski Kit (Competition Keel) - Mountain Ski	5639-878
(B) 8" Ski Kit - Black - Trail Ski	5639-323
(C) 6" Ski Kit - Black - Trail Ski	5639-322
Replacement Wearbars (See page 47, Ref A)	

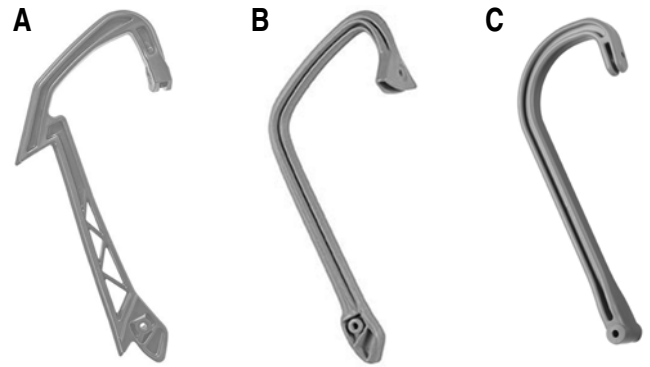

Page 104

ARCTIC CAT SKI HANDLES

Sold in pairs.

Description	p/n
(A) '12 Arctic Cat Saddleless Skis	
Green	5639-743
Orange	5639-744
(B) '05-'11 Arctic Cat Saddleless Skis	
Green	3639-777
Orange	3639-778
(C) Arctic Cat & Parabolic Skis	
Green	3639-781
Orange	3639-865



Page 104

C&A PRO ADX SKIS

Fits all applications except cast aluminum spindles. Includes mounting hardware. Wearbars sold separately. Sold in pairs.

Description	p/n
6" Ski Kit - Black	5639-603
Replacement Wearbars (See page 47, Ref E)	



BLOW-MOLDED SKIS

Includes 4" carbides. Fits all '09 and earlier applications except cast aluminum spindle. Sold in pairs.

Description	p/n
5" Ski Kit - Black	1639-575
Replacement Wearbars (See page 47, Ref C)	



Page 104

SLP POWDER PRO SKIS™

Wearbars sold separately. Fits all applications except cast-aluminum spindle. Sold in pairs.

Description	p/n
7" Ski Kit - Black	5639-326
Replacement Wearbars (See page 47, Ref D)	



UNIVERSAL PLASTIC SKIS

Fits all '09 and earlier Arctic Cat independent front suspensions including cast aluminum spindle style pictured. Includes 4" carbides and all hardware for conversion. Sold in pairs.

Description	p/n
Ski Kit - Black	0639-225
Replacement Wearbars (See page 47, Ref B)	

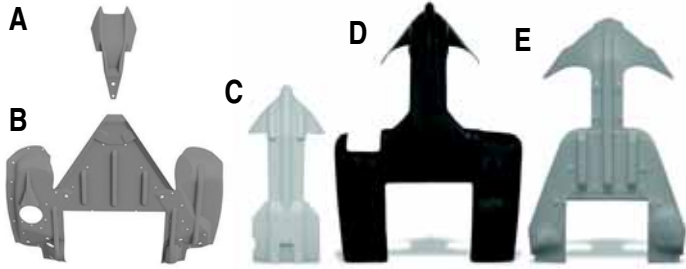

Page 105
SKID PLATES

■ NOTE: '10-'11 Z1 models require trimming for exhaust outlet.

Application	p/n
(A) '12 F 800, F 1100, M 800, M 800 HCR, M 1100, XF 800, XF 800 HC, XF 1100	
Black - Front	5639-745
Green - Front	5639-746
Orange - Front	5639-747
White - Front	5639-748
(B) '12 F 800, F 1100, F 1100 Turbo, M 800, M 800 HCR, M 1100, M 1100 Turbo, M 1100 Turbo HCR, XF 800, XF 800 HC, XF 1100, XF 1100 Turbo, XF 1100 Turbo HC	
Black - Rear	5639-893
Green - Rear	5639-894
Orange - Rear	5639-895
White - Rear	5639-896
(C) '05-'11 M Series; '06-'11 CF; '09-'11 CFR, M8 HCR	
Black	3639-838
Green	3639-839
Orange	4639-564
White	5639-582
Replacement Hardware (includes 12 Steel Rivets (3/16" x .925"), 2 Steel Rivets (3/16" x .750"), and 4 Washers (3/16" x 3/4"))	0641-719
(D) '05-'11 M SERIES; '06-'11 CF; '09-'11 CFR, M8 HCR	
Heavy-Duty Black	5639-223
(E) '12 F5, F570; '10-'11 F Series; '08-'12 T570, TZ1 Touring; '09-'11 Z1, Z1 Turbo; '10-'11 Z1 Turbo EXT; '11 F8 EXT	
Black	4639-567
Replacement Hardware (includes 10 Steel Rivets (3/16" x .750"), 8 Washers (1/4" x 1"), 4 Pan-Head Screws (1/4"-20 x 1 1/4"), 1 Pan-Head Screw (1/4"-20 x 2 1/4"), and 5 Nyloc Nuts (1/4"-20))	4639-684
'00-'06 ZR; '01-'03 ZL; '01-'04 MC; '01-'08 Z; '04-'06 KC	
Black	1639-417
Replacement Hardware	0641-508



Page 105
TUNNEL GRIPS

Application	p/n
'12 F 800, F 1100, F 1100 Turbo, M 800, M 800 HCR, M 1100, M 1100 Turbo, XF 800, XF 1100, XF 1100 Turbo	5639-839
Universal (PR) 4.25" x 15.5"	5639-814



Page 105
GRIP PLATES - PAIR

Application	Color	p/n
'12 F5, F570; '10-'11 F Series; '10-'11 Z1, Z1 Turbo, Z1 Turbo EXT; '11 F8 EXT	Black	5639-328
	Green	5639-329
	Orange	5639-330



WHEELS (IDLER WHEELS)

Includes bearing. Sold individually.

Description	p/n	Description	p/n
(A) 5.63" x .787" ID		(A) 7.12" x .787" ID	
Black	3604-386	Black	3604-063
Green	3604-047	Green	3604-066
Orange	3604-048	Orange	3604-065
Pink	3604-379	Pink	3604-380
Red	3604-044	Red	3604-064
Silver	3604-043	Silver	3604-062
Yellow	3604-040	Yellow	3604-068
(A) 5.63" x .625" ID		(A) 7.12" x .625" ID	
Green	1604-691	Black	1604-683
Silver	1604-693	Green	1604-745
Yellow	2604-122	Silver	1604-971
(A) 6.38" x .625" ID		(B) 8.00" x .787" ID	
Black	3604-387	Black	3604-073
Green	1604-692	Green	3604-075
Orange	1604-765	Orange	3604-071
Red	1604-767	Red	3604-074
Silver	1604-694	Silver	3604-076
(A) 6.38" x .787" ID		(C) 5.63" x .625" ID	
Green	3604-053	Green	0604-981
Orange	3604-054	(C) 6.38" x .625" ID	
Red	3604-052	Green	0604-980
Silver	3604-055		



Page 105
GRIPPER SEAT COVER

Application	p/n
'12 F 800, F 1100, F 1100 Turbo, XF 800, XF 1100, XF 1100 Turbo	5639-845
'12 M 800, M 800 HCR, M 1100, M 1100 Turbo, M 1100 Turbo HCR, XF 800 HC, XF 1100 Turbo HC	5639-846
'10-'12 Sno Pro 500	5639-667
'10-'11 M Series, M8 HCR	5639-666

SNOW MESH

Hood mesh not for use on Fan-Cooled Models.

Application	p/n
Bumper (Coarse Mesh)	
'12 F 1100, F 1100 Turbo, M 1100, M 1100 Turbo, M 1100 Turbo HCR, XF 1100, XF 1100 Turbo, XF 1100 Turbo HC	5639-836
'12 F5, F570; '10-'11 F Series; '08-'12 T570, TZ1 Touring; '09-'12 BC 570; '09-'11 Z1	5639-332
'09-'12 Z1 Turbo Touring, '09-'11 Z1 Turbo	5639-352
'05-'11 M Series; '06-'11 CF; '09-'11 CFR, M8 HCR	5639-169
'09-'12 BC 570 XT, BC Z1 XT (See page 39)	5639-522
Hood (Coarse Mesh) (Liquid-Cooled Models)	
'12 F5; '07-'11 F Series; '08-'12 TZ1 Touring; '09-'12 BC Z1 XT; '09-'11 Z1 (Non-turbo)	5639-458
'05-'11 M Series; '06-'11 CF; '09-'11 CFR, M8 HCR	5639-333
'10-'12 Sno Pro 500	5639-396
'03-'06 FC, SC	5639-633
Clutch (Coarse Mesh)	
'12 F 800, F 1100, F 1100 Turbo, M 800, M 800 HCR, M 1100, M 1100 Turbo, M 1100 Turbo HCR, XF 800, XF 800 HC, XF 1100, XF 1100 Turbo, XF 1100 Turbo HC	5639-835
Intake (Fine Mesh)	
'12 F 800, F 1100, F 1000 Turbo, XF 800, XF 1100, XF 1100 Turbo	5639-947
'05-'11 M Series; '06-'11 CF; '09-'11 CFR, M8 HCR	5639-334
Side Panel, Rear (Coarse Mesh)	
'09-'12 BC Z1 XT	5639-499



TOE HOLD

Sold in pairs.

Application	p/n
'10-'12 Sno Pro 500	5639-611

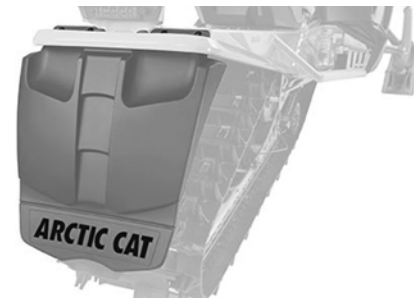

SNOWFLAP

Application	p/n
'12 F 800, F 1100, F 1100 Turbo, XF 800, XF 1100, XF 1100 Turbo Green	5639-840
Orange	5639-841
'12 M 800, M 800 HCR, M 1100, M 1100 Turbo, M 1100 Turbo HCR, XF 800 HC, XF 1100 Turbo HC Green	5639-842
Orange	5639-843

p/n 5639-332

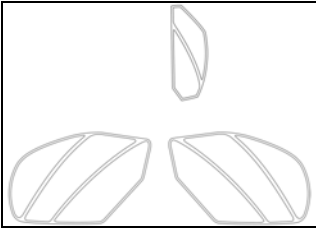

p/n 5639-352

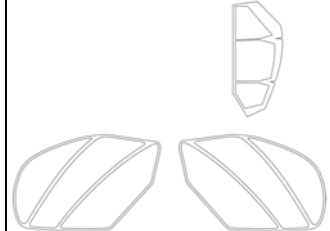

p/n 5639-169

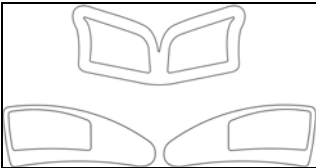

p/n 5639-333

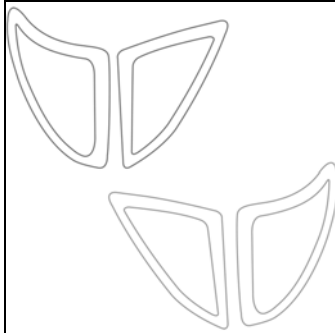

p/n 5639-458

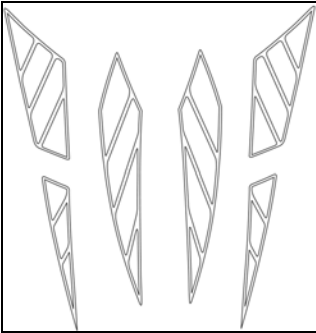

p/n 5639-334

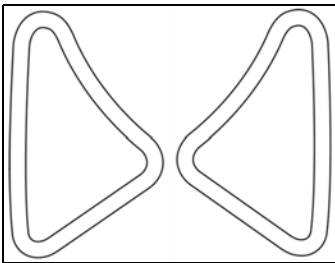

p/n 5639-396

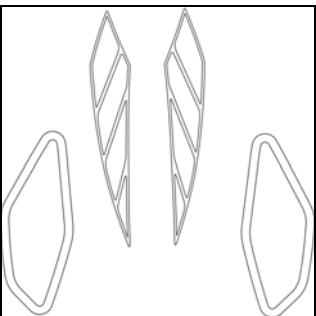

p/n 5639-499

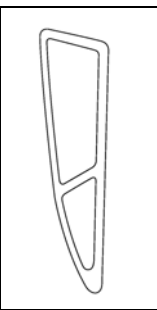

p/n 5639-836

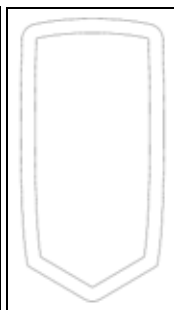

p/n 5639-633



p/n 5639-835

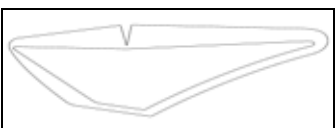

p/n 5639-947

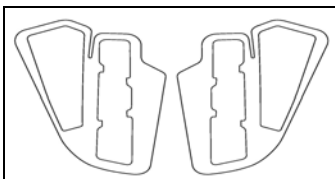



Page 106

WEAR STRIPS

Sold individually.

Application	p/n
121-128"	
Green	2604-819
Orange	2604-289
Black	2604-257
White	2604-543
136-162"	
Green	2604-821
Orange	1604-769
Black	2604-799

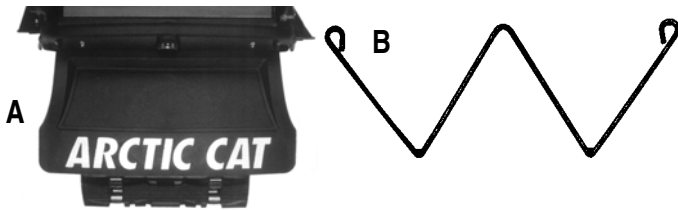

A. SHORT SNOWFLAP

Application	p/n
'99-'06 121" Models	1606-507
Models prior to '99	0616-613

B. SNOWFLAP SUPPORT BRACKET

Application	p/n
'99-'06 121" Models	2706-648



Page 107

HAND MIRROR

Description	p/n
Hand Mirror	4992-810



Page 107

HEADLIGHT COVERS

Not for use at night.

Application	p/n
'12 F 800, F 1100, F 1100 Turbo, M 800, M 800 HCR, M 1100, M 1100 Turbo, M 1100 Turbo HCR, XF 800, XF 800 HC, XF 1100, XF 1100 Turbo, XF 1100 Turbo HC	
Chrome	5639-753
Green Chrome	5639-754
Smoke	5639-755
'12 F5, F570; '07-'11 F Series; '10-'11 Z1, Z1 Turbo, Z1 Turbo EXT; '11 F8 EXT	
Chrome	5639-756
Green Chrome	5639-757
Smoke	5639-758
'05-'11 M Series; '06-'11 CF; '09-'11 CFR, M8 HCR	
Chrome	5639-759
Green Chrome	5639-760
Smoke	5639-761
Replacement Velcro Dots (8 pc)	4639-625

NOTE: Some states and municipalities may have laws prohibiting the use of colored headlight covers. Please check state and local laws before using headlight covers. Arctic Cat Sales Inc. shall not be liable for any claims resulting from illegal use of headlight covers.

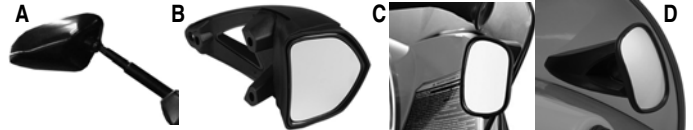

Page 107

A. HOOD-MOUNTED MIRRORS

Application	p/n
'12 F 800, F 1100, F 1100 Turbo, M 800, M 800 HCR, M 1100, M 1100 Turbo, M 1100 Turbo HCR, XF 800, XF 800 HC, XF 1100, XF 1100 Turbo, XF 1100 Turbo HC	
Single, RH	5639-830
Single, LH	5639-831
Pair	5639-832

B. WINDSHIELD MIRRORS

Application	p/n
'12 F5, F570; '10-'11 F Series; '08-'12 T570, TZ1 Touring; '09-'11 BC, Z1, Z1 Turbo; '12 F, M, XF Accessory Mid and High Windshields	
Black - Single	4639-734
Black - Pair	4639-733

C.-D. COMPACT MIRRORS

Sold individually.

Application	p/n
(C)'05-'11 M Series; '06-'11 CF; '09-'11 CFR, M8 HCR	4639-463
(D)'12 F5, F570; '10-'11 F Series; '08-'12 T570, TZ1 Touring; '09-'11 BC, Z1, Z1 Turbo	4639-565

Mountain Accessories

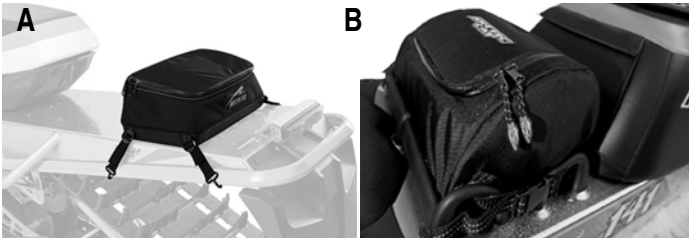

Page 109

MOUNTAIN PACK

Application	p/n
(A) '12 M 800, M 800 HCR, M 1100, M 1100 Turbo, M 1100 Turbo HCR, XF 800, XF 800 HC, XF 1100, XF 1100 Turbo, XF 1100 Turbo HC; '09-'11 M Series, M8 HCR	5639-710
(B) '05-'08 M Series; '06-'08 CF	3639-725
Replacement Straps w/Hook (Pkg 4)	0641-994



Page 109

MOUNTAIN GEAR BAG

Application	p/n
(A) '12 M 800, M 800 HCR, M 1100, M 1100 Turbo, M 1100 Turbo HCR, XF 800, XF 800 HC, XF 1100, XF 1100 Turbo, XF 1100 Turbo HC	5639-711
(B) '09-'11 M Series, M8 HCR	5639-044
(C) '05-'08 M Series; '06-'08 CF	4639-727
Replacement Straps w/Hook (Pkg 4)	0641-994

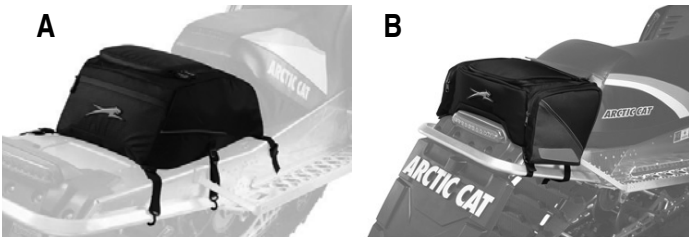

Page 109

TUNNEL GEAR BAG

Application	p/n
(A) '12 F5, F570; '10-'11 F Series; M Series, Z1, Z1 Turbo, Z1 Turbo EXT; '11 F8 EXT	5639-574
(B) '09-'11 M Series, CF, CFR, M8 HCR	5639-043
Replacement Straps w/Hook (Pkg 4)	0641-994
Replacement Cam Buckles (Pkg 2)	0639-089



Page 109

TUNNEL PACK

Application	p/n
'10-'12 Sno Pro 500; '10-'11 M Series	5639-433



Page 109

HANDLEBAR BAG

Application	p/n
'12 M 800 SP, M 800 HCR, M 1100 SP, M 1100 Turbo SP, M 1100 Turbo HCR, XF 800 HC, XF 1100 Turbo HC; '09-'12 BC 570, BC XT; '05-'11 M Series; '06-'11 CF; '04-'06 KC	5639-709



Page 110

TANK PADS

Sold in pairs.

Application	p/n
(A) '12 F 800, F 1100, F 1100 Turbo, M 800, M 800 HCR, M 1100, M 1100 Turbo, M 1100 Turbo HCR, XF 800, XF 1100, XF 1100 Turbo	
Black	5639-764
Replacement Rivets (6/pk)	5639-930
(B) '05-'11 M Series; '06-'11 CF; '09-'11 CFR, M8 HCR	
Black	5639-050
Green	5639-051
Orange	5639-052
Replacement Mounting Screw '05-'07 (Std)	8017-427
Replacement Mounting Screw '08-'10 (Metric)	8475-512
(C) '10-'12 Sno Pro 500	
Black	5639-612



TANK JACKET

Application	p/n
'05-'11 M Series; '09-'11 M8 HCR	
Black	5639-053
'06-'11 CF; '09-'11 CFR	
Black	5639-056
Replacement Velcro (Pair)	4639-602



Page 110

TANK GRIPS

Application	p/n
'12 F 800, F 1100, F 1100 Turbo, M 800, M 800 HCR, M 1100, M 1100 Turbo, M 1100 Turbo HCR, XF 800, XF 800 HC, XF 1100, XF 1100 Turbo, XF 1100 Turbo HC	5639-762



Page 110

WINDSHIELD BAG

Application	p/n
'12 F 800, F 1100, F 1100 Turbo, M 800, M 800 HCR, M 1100, M 1100 Turbo, M 1100 Turbo HCR, XF 800, XF 1100, XF 1100 Turbo, XF 800 HC, XF 1100 Turbo HC	5639-712
'05-'11 M-Series; '06-'11 CF, '09-'11 CFR, M8 HCR	4639-428

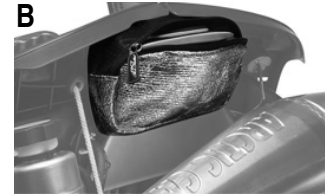

Page 110

GOOGLE HOLDER

CAUTION: Do not leave goggles in holder for an extended period of time. Excessive heat may damage goggles.

Application	p/n
(A) '12 F 800, F 1100, F 1100 Turbo, M 800, M 800 HCR, M 1100, M 1100 Turbo, M 1100 Turbo HCR, XF 800, XF 800 HC, XF 1100, XF 1100 Turbo, XF 1100 Turbo HC	5639-767
(B) '05-'11 M Series; '06-'11 CF; '09-'11 CFR, M8 HCR	4639-732

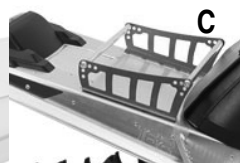
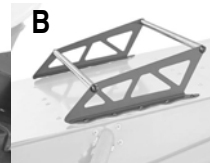

Page 111

A. BILLET RACK

8" x 13" W

Application	p/n
'09-'11 M Series, M8 HCR	
Black	5639-597
Silver	5639-598

B. PROCLIMB RACK

8" x 12" W

Application	p/n
'12 M 800, M 800 HCR, M 1100, M 1100 Turbo, M 1100 Turbo HCR, XF 800 HC, XF 1100 Turbo HC	
Green	5639-773
Orange	5639-774
Silver	5639-775

C. M SERIES RACK

8 3/4" x 15" W

Application	p/n
'09-'11 M Series, M8 HCR	
Green	4639-975
Orange	4639-976
Unpainted	4639-977



Page 111

RACK STRAP

Application	p/n
(A) '12 M 800, M 800 HCR, M 1100, M 1100 Turbo, M 1100 Turbo HCR, XF 800, XF 1100, XF 1100 Turbo; '09-'11 M Series, M8 HCR, CF (Ratchet)	4639-978
(B) '05-'08 M Series; '06-'08 CF (Cam Buckle)	3639-579



Page 112

FLOAT AVALANCHE AIRBAGS

For technical assistance, contact BCA at 303-417-1345, ext. 0. Includes pressurized air cylinder, requires hazardous material shipping.

Description	p/n
(A) Float 30	5639-482
(B) Float 18	5639-812



Page 111

MOUNTAIN SEAT

Application	Color	p/n
'05-'09 M Series; '06-'11 CF; '09-'11 CFR	Black	5639-600
	Green	5639-601
	Orange	5639-602



Page 112

AVALANCHE BEACONS

For technical assistance contact: BCA at 303-417-1345, ext. 0.

Description	p/n
BCA Tracker 2 (457 kHz)	5639-610



Page 111

BEARD MOUNTAIN SEAT

Application	p/n
'05-'11 M Series; '06-'11 CF; '09-'11 CFR	5639-875



Page 112

BACKCOUNTRY KIT

Description	p/n
BCA Squall Backpack, Tracker2 Beacon, B-1 EXT Shovel, Profile 240 Probe	5639-768



Page 113

BACKPACKS

Description

- (A) BCA Squall H²O - 2.0 lbs, 27 Liter capacity
 (B) BCA Throttle H²O - 3.3 lbs, 35 Liter capacity
 (C) Ogio Capital - 2.6 lbs, 34 Liter capacity

p/n

5639-769
 5639-653
 5639-432

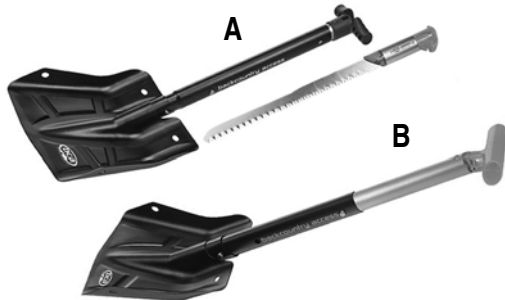

Page 113

SNOW SHOVELS

Description

- (A) BCA A-2 EXT with Saw (Extendable handle)
 (B) BCA B-1 EXT (Extendable handle)

p/n

5639-786
 5639-770

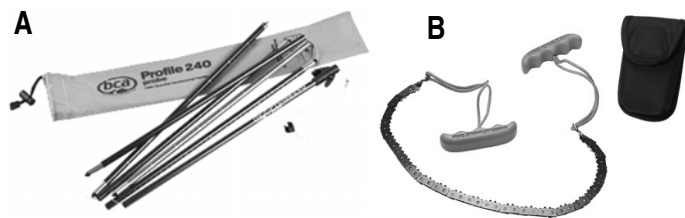

Page 113

A. AVALANCHE PROBE

Description

BCA Profile 240

p/n

5639-266

B. POCKET SAW

Application

Saw with Pouch

p/n

4639-979



Page 114

ICE SCRATCHERS

■NOTE: Models listed have mounting holes in rails. Installation on other models will require drilling mounting holes.

Application

'12 M 800, M 1100, M 1100 Turbo, XF 800, XF 800 HC, XF 1100, XF 1100 Turbo, XF 1100 Turbo HC; '09-'11 M Series, M8 HCR, CF

p/n

5639-897

Replacement Wire - RH

1704-734

Replacement Wire - LH

1704-735

Replacement Mounting Hardware (Pair)

5639-941



Page 114

VENTED HOOD PANELS

Description

'12 F 800, F 1100, F 1100 TURBO, M 800, M 800 HCR, M 1100, M 1100 Turbo, M 1100 Turbo HCR, XF 800, XF 800 HC, XF 1100, XF 1100 Turbo, XF 1100 Turbo HC

p/n

Hood Panel Kit with Screens

Black

5639-862

Green

5639-863

Orange

5639-864

White

5639-991

Screen Set Only

Hood Screens (Pair)

5639-948

Replacement Screens

Hood Screen - RH

6606-468

Hood Screen - LH

6606-469



VENTED HEADLIGHT COWL (INTAKE)

Description

'12 F 800, F 1100, F 1100 TURBO, XF 800, XF 1100, XF 1100 Turbo

p/n

Screen Set Only

Headlight Cowl Screens (Pair)

5639-947

Replacement Screens

Intake Screen - RH

0608-688

Intake Screen - LH

0608-689

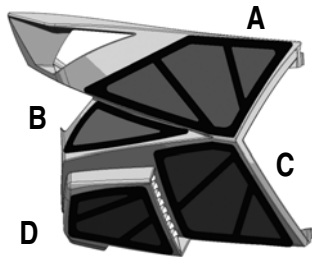

Page 114

VENTED SIDE PANELS

Description

'12 F 800, F 1100, F 1100 Turbo, M 800, M 800 HCR, M 1100, M 1100 Turbo, M 1100 Turbo HCR, XF 800, XF 800 HC, XF 1100, XF 1100 Turbo, XF 1100 Turbo HC

Side Panel Kit with Screens

Black	5639-865
Green	5639-866

Screen Set Only

Side Panel Screens (Set of 7)	5639-949
-------------------------------	----------

Replacement Screens

(A) Upper RH	6606-470
(A) Upper LH	6606-471
(B) Mid LH	6606-485
(C) Lower, Rear - RH	6606-474
(C) Lower, Rear - LH	6606-475
(D) Lower, Front - RH	6606-472
(D) Lower, Front - LH	6606-473

p/n

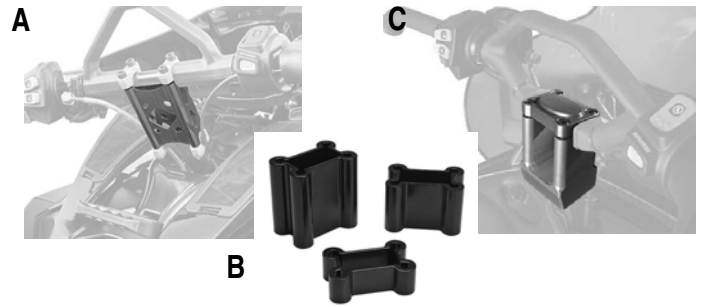

Page 115

A. HANDLEBAR RISERS

Application

'12 F 800, F 1100, F 1100 Turbo, M 800 (STD), M 1100, M 1100 Turbo, XF 800, XF 1100, XF 1100 Turbo

	p/n
4.5" - Black	5639-881
5.5" - Black	5639-882
6.5" - Black	5639-883
7.5" - Black	5639-884
8.5" - Black	5639-885
4.5" - Green	5639-886
5.5" - Green	5639-887
6.5" - Green	5639-888
7.5" - Green	5639-889
8.5" - Green	5639-890

B. HANDLEBAR RISERS

Application

'05-'11 M Series (STD); '06-'11 CF (STD)

	p/n
1" - Black	5639-776
2" - Black	5639-777
3" - Black	5639-778

C. ANGLED HANDLEBAR RISER

Application

'05-'11 M Series (STD); '06-'11 CF (STD)

	p/n
2" - Silver	5639-503
3" - Silver	5639-504

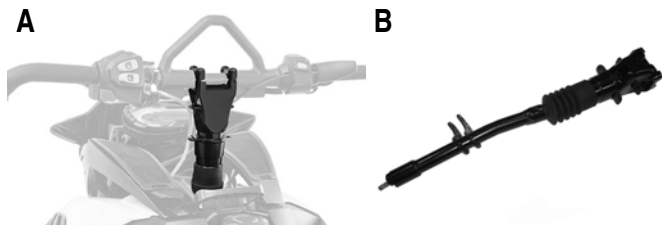

Page 115

TELESCOPIC STEERING POST

■NOTE: Not available for CF5 - insufficient cable length.

Application

(A) '12 F 800, XF 800, M 800 (STD)	5639-813
(B) '09-'11 M Series (Std), CF (Std)	5639-516

p/n



Page 115

SWITCH GUARDS

Application

'12 M 800, M 800 HCR, M 1100, M 1100 Turbo, M 1100 Turbo HCR, XF 800, XF 800 HC, XF 1100, XF 1100 Turbo, XF 1100 Turbo HC; '07-'11 M Series; '09-'11 M8 HCR

p/n

5639-580



Page 115

OFFSET RISER

Application

'09-'11 M Series; M8 HCR w/Telescopic Post

Black	5639-595
Silver	5639-596

p/n



Page 116
MOUNTAIN STRAP

Application '10-'11 Z1 Turbo EXT; '11 F8 EXT **p/n** 5639-358



Page 116
LIGHTWEIGHT FRONT AXLE KIT

Application '05-'08 M Series **p/n** 4639-995

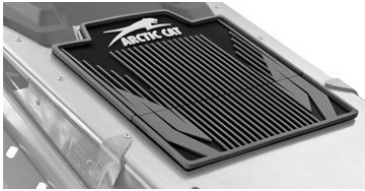

Page 116
RACK PAD

Application '09-'11 M Series, M8 HCR, CF (12.75-in. Long) **p/n** 4639-988
 '10-'11 F Series, Z1, Z1 Turbo, Z1 Turbo EXT; '11 F8 EXT (21-in. Long) 5639-351



Page 116
HI-TEMP CAM ROLLER

Set of 6.

Application ACT Driven Pulley **p/n** 5639-468

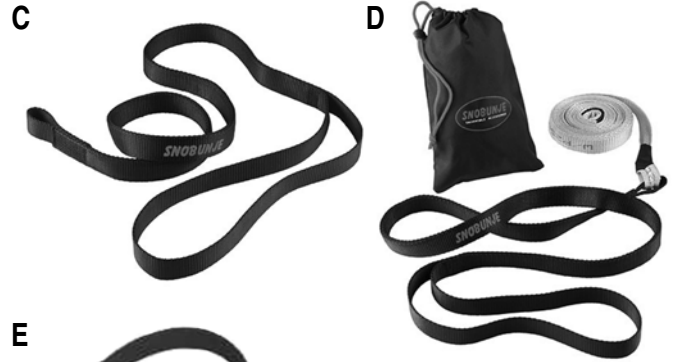
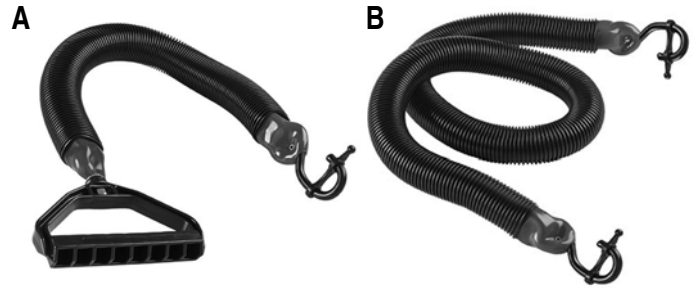

Page 116
SNOBUNJE PULLING TOOLS

Description **p/n**
 (A) Rattler (32" Long, 1.5 lbs) 5639-639
 (B) Cobra (52" Long, 2.5 lbs) 5639-640
 (C) Adapter Strap (60" Long) 5639-642
 (D) Slicktape 20 (20' Long) 5639-643
 (E) Cobra Adapter Strap (15" Long) 5639-641



Page 116
PULL STRAP

Description **p/n**
 Pull Strap 5639-512

A



A. FOUR WHEEL KIT

Adds two inside wheels.

Application
'09-'11 M Series

p/n
5639-528

B. TWO WHEEL KIT

Application
'08 M Series; '09-'11 CF
*'05-'07 M Series, '04 MC, '04-'06 KC
*Requires Spacer (p/n 1604-810)

p/n
4639-997

B



38" A-ARM KIT

Converts models with 40"-41" Ski Stance to 38"-39". Available with Black, Green, or White A-Arms. Includes Upper & Lower A-Arms, Tie-Rod Tubes and Shock Spacers (Requires rebuilding shocks to add a spacer to shorten travel).

Application	p/n
'12 M 800 (Std), M 800 SP, M 1100 (Std), M 1100 SP, M 1100 Turbo (Std), M 1100 Turbo SP, M 1100 Turbo HCR	
Black	5639-938
Green	5639-939
White	5639-940

Utility



Page 118

BEARCAT GEAR BAG

Application

'09-'12 BC 570 XT, BC Z1 XT

p/n

5639-049



Page 119

THIRD SEAT

Application

'09-'12 BC 570 XT, BC Z1 XT

p/n

5639-063



Page 118

TUNNEL PACK

Application

'09-'12 BC 570 XT, BC Z1 XT

p/n

6606-252



Page 119

CARGO RACK

Application

'09-'12 BC 570 XT, BC Z1 XT

p/n

5639-062



Page 118

SNOW MESH

Application

'09-'12 BC 570 XT, BC Z1 XT

*For other BC applications, see page 30.

p/n

5639-522

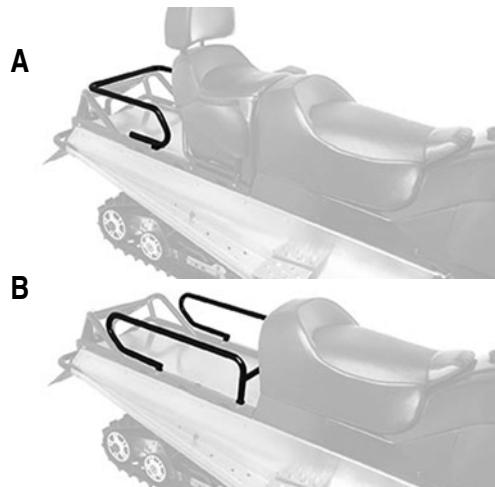

Page 119

SIDE RAILS

Application

'09-'12 BC 570 XT, BC Z1 XT

(A) Short

(B) Long

p/n

5639-060
5639-061

Replacement Strap for p/n 5639-060 (ea)

0641-993



Page 119

LIGHT BAR

Application
'09-'12 BC 570 XT, BC Z1 XT

p/n
5639-803



Page 119

STROBE LIGHT

Application
Fits Light Bar (5639-803)

p/n
5639-871

GROOMER HARNESS KIT

Includes dash-mounted control switches, wiring harness, and rear outlet.

Application
'09-'12 BC 570 XT, BC Z1 XT

p/n
5639-876

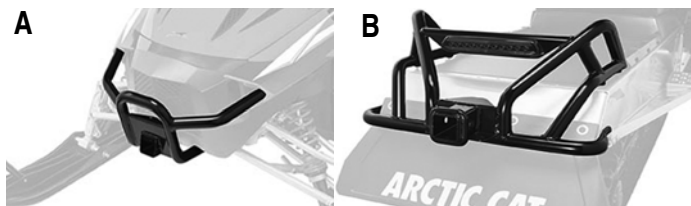

Page 120

RECEIVER BUMPER

Application
'09-'12 BC 570 XT, BC Z1 XT

(A) Front
(B) Rear
Replacement Hitch Cover

p/n
5639-338
5639-339
0641-248



Page 120

A. HITCH

Pintle hitch not included.

Application
'09-'12 BC XT - Receiver Bumper (p/n 5639-339)

p/n
5639-386

B. PIVOT HITCH CONVERSION KIT

Application
'09-'12 BC 570 XT, BC Z1 XT; '06-'07 BC WT; '07 BC 570

p/n
5639-387

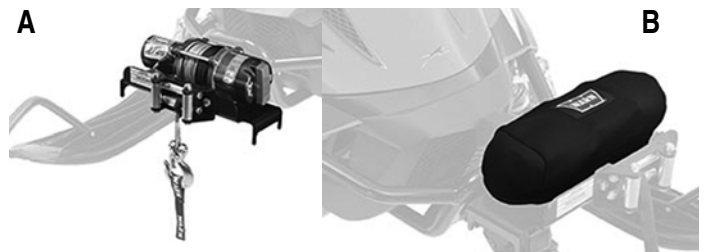

Page 120

RECEIVER WINCH

Application
(A) '09-'12 BC 570 XT, BC Z1 XT
(B) Winch Cover

p/n
5639-340
5639-459

Replacement Components

Fairlead, Roller	0441-403
Mounting Pin	1441-977
Mounting Pin Clip	1441-143
Mounting Plate 2" Receiver	0641-256
Solenoid	0409-080
Switch, Handlebar	0641-249



Page 120

TRANSPORT MOUNT

Application
'09-'12 BC 570 XT, BC Z1 XT

p/n
5639-457



Page 120
REAR HARNESS

Application	p/n
'09-'12 BC 570 XT, BC Z1 XT	5639-456



Page 120
WARN PORTABLE WINCH KIT

Description	p/n
Winch Kit (Models with Standard Battery)	4639-138
Replacement Components	
Quick-Disconnect Plug	0641-940
Synthetic Rope	0641-941



Page 120
SNOW PLOW PUSH FRAME

Requires Front Receiver Bumper and Receiver Winch.

Application	p/n
'09-'12 BC 570 XT, BC Z1 XT	5639-341
Replacement Components	
Eyebolt	0441-332
Mounting Pin	1441-977
Mounting Pin Clip	1441-143
Spring - Kickover	0741-009

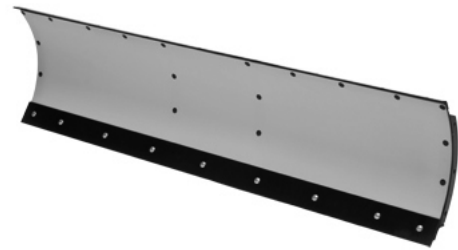

Page 120
SNOW PLOW BLADE

60" Blade.

Application	p/n
'09-'11 BC XT	0436-296
Optional Accessories	
Edge Marker Kit	0436-235
Side Plate Kit	0436-232
Snow Deflector	0436-299
Replacement Components	
Skid	0441-341
Wearbar	0441-447



Page 121
CARGO SLEDS

Additional shipping charges may apply. Order in multiples of 3.

Description	p/n
74" L X 38" W X 17" D, 48 lb, Capacity - 600 lb	4639-126



Page 121
CARGO SLED RUNNER KIT

Application	p/n
Cargo Sled (4639-126) 6 Wearstrips	4639-131



Page 121

CARGO SLED COVER

Attaches with elastic cord.

Application
Cargo Sled (4639-126)

p/n
4639-129

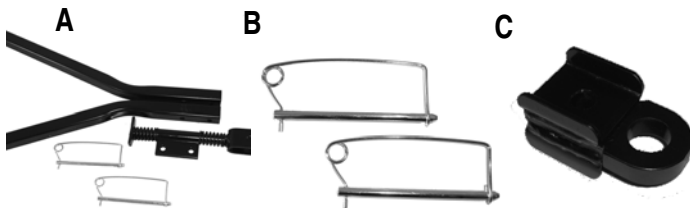

REPLACEMENT HARDWARE

Description
(A) Replacement Hitch
(B) Replacement Pins (Pair)
(C) Pintle Hitch Adapter

p/n
4639-941
5639-236
5639-463

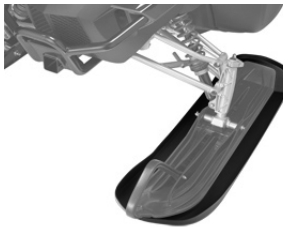

Page 121

SKI SKINS

Fits 8" Saddleless Skis. 12" wide. Sold in pairs.

Application
'09-'12 BC 570, BC 570 XT, BC Z1 XT

p/n
5639-254



Page 121

BACKUP LIGHT KIT

Application
'09-'12 BC Z1 XT

p/n
5639-389



Page 121

PASSENGER HAND WARMERS

■NOTE: Not available for fan-cooled models - power output insufficient.

Application
(A) '09-'12 BC Z1 XT; '11-'12 BC Z1 XT Ltd
(B) '08-'09 T500

p/n
4639-970
4639-802

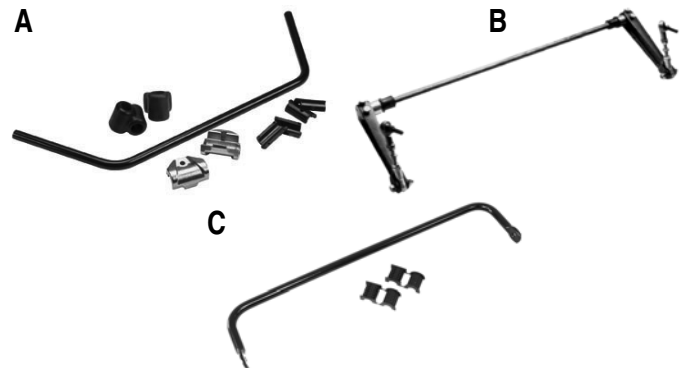

SWAY BAR KITS

■NOTE: '11-'12 Sno Pro 500 requires Mounting Hardware Kit (p/n 5639-635).

Application
(A) '09-'12 BC 570 XT; '10-'12 BC Z1 XT
(A) '09-'12 BC 570
(B) '99-'07 PA, Z; '06-'08 BC (7/16-in. Dia)
(C) '10-'12 Sno Pro 500 - 11.7 mm
(C) '10-'12 Sno Pro 500 - 12.7 mm
(C) '10-'12 Sno Pro 500 - 14.3 mm

p/n
5639-441
5639-200
4639-322
4639-961
4639-962
4639-963

Heavy-Duty Sway Bar (1/2" Dia bar)
'99-'07 Models with Standard 7/16" Sway Bar

0703-193



RACK MAT

Application
'09-'12 BC 570 XT, BC Z1 XT

p/n
5606-368



RADIATOR KIT

Includes radiator with electric cooling fan, hoses, and wiring.

Application
'09-'12 BC Z1 XT

p/n
4639-967



OVERLOAD SPRING KIT

Application
'09-'10 BC 570

p/n
5639-106



PASSENGER SEAT KIT

Includes seat assembly with backrest.

Application
'09-'10 BC 570

p/n
5639-201

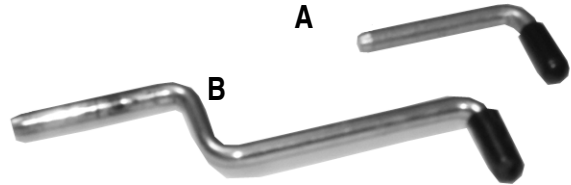

REPLACEMENT PINS

Description
(A) Replacement Pins (Pkg 5)
(B) Pin '06-'08 BC WT (Each)

p/n
0436-759
1623-422

Bearcat Trail Groomer

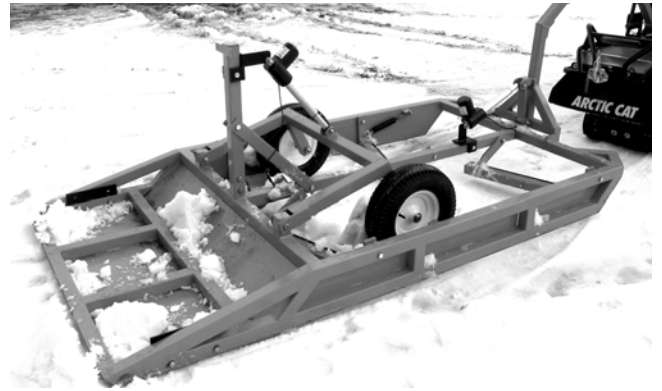

The Bearcat Trail Groomer is designed to maintain a 4-ft wide trail

- Two electric actuators that control cutting depth and wheel lift are pre-wired for the Bearcat Z1 XT GS rear outlet
- Four spring-loaded, pivoting cutting edges (front two are serrated) ('12 Bearcat Z1 XT models have pre-drilled mounting holes, '09-'11 models require drilling)
- Goose-neck hitch features an anti-scalping design
- Includes a snowmobile hitch plate with 1-7/8-in. ball that bolts directly to pre-drilled tunnel rails
- 52-in. x 96-in., 350 lb

■NOTE: The '12 Bearcat Z1 XT GS has an under-seat radiator and Groomer switches and outlet factory-installed. All other '09-'12 Bearcat Z1 XT models require a Radiator Kit (page 45) and Groomer Harness Kit when pulling a Trail Groomer.

Description	Application	p/n
Trail Groomer w/Mounting Plate & Ball	'12 BC Z1 XT GS	5639-891
Groomer Harness Kit	'09-'12 BC Z1 XT	5639-876
Hitch Plate w/Ball		5639-931

Includes dash-mounted control switches, wiring harness, and rear outlet

120



HAND WARMER KIT

Includes external hand warmer elements, wiring, and switch.

Application
'01-'12 120 Models

p/n
2639-019

A



B

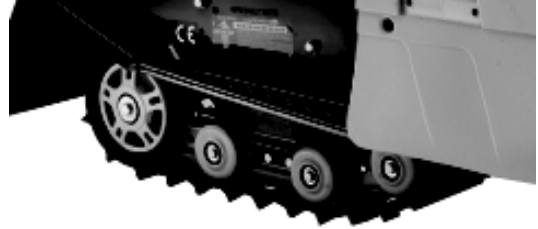

WHEEL KITS

Description

- (A) Ski Wheel Kit
(includes two 8-in. wheels and mounting hardware)
- (B) Rear Suspension Wheel Kit (Black)
(includes six idler wheels and mounting hardware)

Year	p/n
'01-'12	1639-795
'01-'12	5639-346



HEAVY DUTY SHOCK KIT

Includes two shock assemblies with springs.

Application
'01-'05 120 Models

p/n
4639-137

Tracks

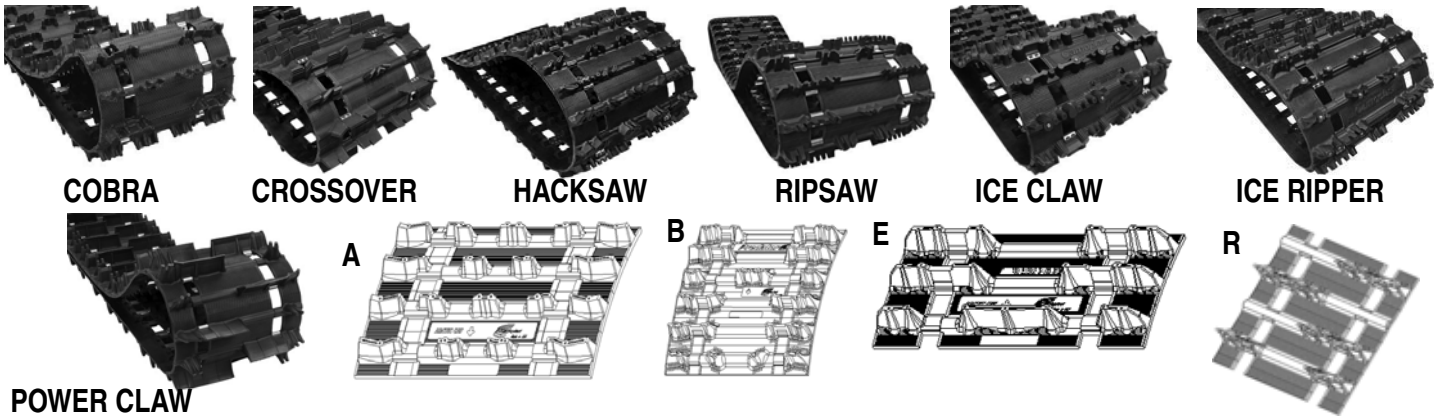

POWER CLAW

Page 123

TRACKS - 2007-CURRENT APPLICATIONS

Tracks listed are required for use on 2007 and newer models with ACT drive and reverse but will also fit older models. All tracks listed feature an "All Open" window configuration with 2-ply construction unless noted. Pitch is measured at center of rods.

PERFORMANCE (2.52 P)

p/n	Dimensions (Studs)	Style	Duro	Weight	Clips
*1602-976	15" x 121" x 1.00"	Hacksaw	80/70	33	Every 3rd
*2602-268	15" x 121" x 1.352"	Cobra (Single-Ply)***	80	32	Every Other
*2602-002	15" x 121" x 1.25"	Ripsaw	80/70	36	Every 3rd
*2602-047	14" x 128" x 1.00"	Hacksaw	80/70	34	Every 3rd
*2602-019	15" x 128" x 1.00"	Hacksaw	80/70	36	Every 3rd
*2602-162	15" x 128" x 1.352"	Cobra***	80	37	Every Other
*2602-255	15" x 128" x 1.352"	Cobra (Single-Ply)***	80	34	Every 3rd
*2602-046	15" x 128" x 1.25"	Ripsaw	80/70	41	Every 3rd
*2602-835	15" x 128" x 1.50"	Ripsaw	80/70	42	Every 3rd
*1602-997	15" x 136" x 1.25"	Ripsaw	80/70	42	Every 3rd
*2602-005	15" x 136" x 1.50"	Ripsaw	80/70	42	Every 3rd

PERFORMANCE (2.86 P)

2602-474	15" x 128" x 1.25"	Ripsaw (Opt Sno Pro XC)	80	39	Every Other
2602-490	15" x 128" x 1.25"	Ripsaw II	80	39	Every Other
2602-491	15" x 128" x 1.352"	Cobra (Sno Pro XC)***	80	36	Every Other
2602-485	15" x 128" x 1.70"	Sno Pro (Sno Pro SX)	80	42	Every Other

TOURING (2.52 P)

*2602-003	15" x 136" x 1.00"	Hacksaw	80/70	37	Every 3rd
*2602-101	15" x 144" x 1.00"	Hacksaw	80/70	40	Every 3rd
*2602-163	15" x 144" x 1.352"	Cobra	80	41	Every Other
*2602-350	15" x 144" x 1.50"	Crossover (Single-Ply)	80	47	Every 3rd

MOUNTAIN TRACKS (3.0 P)

2602-169	15" x 141" x 1.352"	Cobra (Single-Ply)***	80	38	Every Other
2602-170	15" x 141" x 1.60"	Cobra (Single-Ply)	80	40	Every Other
2602-166	15" x 141" x 2.25"	Power Claw (Single-Ply)	80	44	Every Other
2602-167	15" x 153" x 2.25"	Power Claw (Single-Ply)	80	48	Every Other
2602-399	15" x 153" x 2.25"	Power Claw (Single-Ply)	85	48	Every Other
2602-168	15" x 162" x 2.25"	Power Claw (Single-Ply)	80	50	Every Other
2602-367	15" x 162" x 2.25"	Power Claw (Single-Ply) (Notched)	80	48	Every Other
2602-438	15" x 162" x 2.25"	Power Claw (Single-Ply)	85	50	Every Other

UTILITY (2.52 P)

2602-314	15" x 151" x 1.25"	Ripsaw (Single-Ply)	80	45	Every 3rd
0602-962	20" x 156" x 1.00"		60	63	Fully Clipped
1602-869	20" x 156" x 1.25"		80	67	Fully Clipped

UTILITY (2.86 P)

2602-358	20" x 154" x 1.375"	(Single-Ply)	80/70	58	Every 3rd
----------	---------------------	--------------	-------	----	-----------

ICE TECH SERIES (2.52 P)**

*2602-030	15" x 121" x 1.00" (240)	ICE Claw	70	36	Every 3rd
*2602-032	15" x 121" x 1.25" (258)	ICE Ripper	70	37	Every 3rd
2602-376	15" x 128" x 1.25" (272)	ICE Ripper	70	39	Every 3rd

* ACT Quiet Tracks are for use on '03 and newer models only.

**To protect the tunnel from possible stud damage, a Tunnel Protector Kit (page 53) should be installed on models not equipped

***Cobra 1.352" tracks have a standard lug height of 1.25". The overall lug height including the extended "towers" is 1.352".

2009-2012 TRACK APPLICATION

Model	Year	Single-Ply	2-Ply
Bearcat 570	'10-'12	2602-314	2602-163
	'09		
Bearcat 570 XT, Z1 XT	'11-'12	2602-358	
	'09-'11		1602-869
	'12		1602-869
Bearcat Z1 XT GS			
Crossfire	'09-'11	2602-169	
Crossfire Sno Pro	'09-'11	2602-170	
CFR	'09-'11		2602-047
F 800, 1100 LXR	'12		2602-019
F 800, 1100 Sno Pro (Inc. Turbo)	'12		2602-046
F 1100 Turbo LXR	'12		2602-046
F Series (Std), LXR	'09-'12		2602-019
F Series Sno Pro	'10-'11		2602-046
	'09	2602-255	
Sno Pro 500	'11-'12		2602-019
	'10	2602-255	
Z1 (Std), LXR	'09-'11		2602-019
Z1 Turbo (Std)	'09-'10		2602-019
Z1 Turbo LXR	'10-'11		2602-046
	'09	2602-255	
Z1 Turbo Sno Pro	'10-'11		2602-046
	'09	2602-255	
F8 EXT, Z1 Turbo EXT	'10-'11		2602-163
T570, TZ1 Touring	'09-'12		2602-101
TZ1 Turbo Touring	'09-'12		2602-163
XF 800, 1100 LXR (Inc Turbo)	'12	2602-169	
XF 800, 1100 Sno Pro (Inc Turbo)	'12	2602-170	
Z1 Turbo EXT, F8 EXT Optional Tracks			
Standard Length Option	1602-137	144" x 2.00"	
Long Track Kit Option	2602-367	162" x 2.25"	

NOTE: For more information on the Arctic Cat Track Exchange Program, see page 1.

TRACKS - 2006-PRIOR APPLICATIONS

Tracks listed below will not fit 2007 and newer models with ACT drive and reverse.

15" TRACKS (2.52 P)

p/n	Dimensions	Style	Duro	Weight	Clips	Windows
*1602-756	121" x .850"	A	60	34	Every 3rd	Every 3rd Closed
2602-398	121" x 1.00"	Hacksaw NQ	80/70	33	Every 3rd	All Open
*1602-504	121" x 1.00"	B	80/60	34	Every 3rd	Every 3rd Closed
2602-396	121" x 1.25"	Ripsaw NQ	80/70	36	Every 3rd	All Open
2602-397	121" x 1.352"	Cobra NQ (Single-Ply)	80	32	Every Other	All Open
*1602-506	121" x 1.375"	E	80/60	40	Fully Clipped	All Open
2602-004	121" x 1.50"	Ripsaw	80/70	38	Every 3rd	All Open
*1602-537	136" x 1.25"	B	80/60	44	Every 3rd	Every 3rd Closed
1602-326	136" x 2.00" w/o Notch	Challenger	80	50	Fully Clipped	All Open

15" TRACKS (3.0 P)

1602-607	141" x 1.60"	R	80	40	Every Other	All Open
----------	--------------	---	----	----	-------------	----------

13.5" TRACKS (2.52 P)

*1602-502	128" x 1.00"	E	80/60	33	Every 3rd	Every 3rd Closed
*1602-886	128" x 1.00"	Hacksaw	80/60	34	Every 3rd	Every 3rd Closed
*1602-503	128" x 1.375"	E	80/60	39	Fully Clipped	All Open
1602-750	144" x 1.25"	A	80/60	34	Every 3rd	All Open

MISC. TRACKS

0602-927	Kitty Cat
1602-015	120 (10" x .688")

- *Cobra 1.352" tracks have a standard lug height of 1.25". The overall lug height including the extended "towers" is 1.352".*
- *60 Durometer is a softer compound and is preferred by deep powder riders.*
- *80 and 90 Durometer is a harder compound to give greater penetration and are preferred hill climb tracks.*
- *80/60, 80/70 Durometer are dual compound tracks with the lug tip 60 or 70 durometer and the remainder 80 durometer.*
- *Tracks w/o Notch fit '03-'04 MC models.*
- *2.25" tracks fit '99-'04 MC models.*
- *NonQuiet (NQ) Tracks can be used on competitive brands.*

MAXIMUM LUG HEIGHT

Model	Year	Height
CF	'09-'11	2.25"
	'06-'08	2.00"
F Series	'07-'11	1.50"
FC (ACT)	'05-'06	1.70"
JR	'07-'08	1.50"
T570, TZ1	'08-'11	1.25"
Z1	'09-'11	1.50"
136" Straight Tunnel Models		1.60"
F	'12	2.25"
XF	'12	2.25"

Wearbars

Ski Applications					
	A	B	C	D	E
Standard Wearbars	'05-'12 Saddleless '03-'06 FC, SC '02-'06 ZR	ZR-Style, Parabolic, Deep Snow, Universal Plastic Ski	Blow-Molded Plastic Ski	SLP Powder Pro	C&A Pro ADX
7/16" Diameter Round Host Bar (Pair)	p/n	p/n	p/n	p/n	p/n
Hardweld Wearbar (No Carbide Inserts)	3639-309	0639-198	1639-744		
4" Carbide With Hardweld			1639-527		
6" Carbide With Hardweld			1639-528		
1/2" Diameter Round Host Bar (Pair)					
4" Carbide With Hardweld	3639-310	3639-978		3639-420	
6" Carbide With Hardweld	3639-311	1639-521		3639-421	5639-604
8" Carbide With Hardweld	3639-312	0639-378			5639-605
10" Carbide With Hardweld	3639-313				
5/8" Diameter Round Host Bar (Pair)					
8" Carbide With Hardweld	3639-314				
10" Carbide Without Hardweld	3639-315				5639-606
Shaper Wearbars					
4.5" Carbide (Pair)	4639-949			5639-195	
6" Carbide (Pair)	4639-950			5639-196	
7.5" Carbide (Pair)					4639-952
9" Carbide (Pair)	4639-951			5639-197	4639-953

■NOTE: The accessory Saddleless Ski wearbars listed use a 4-bolt stud pattern. When using accessory wearbars on Saddleless Skis with a 3-bolt stud pattern, it will be necessary to drill another mounting hole in the ski.

Dual Wearbars	'05-'12 Saddleless '03-'06 FC, SC '02-'06 ZR	ZR-Style, Para- bolic, Deep Snow, Universal
Dooly™ Twin Carbide Wearbars (Each)		
Hardweld Wearbar	5639-879	
4" Carbide With Hardweld	3639-343	3639-346
6" Carbide With Hardweld	3639-344	3639-347
8" Carbide With Hardweld	3639-345	3639-348
Deuce™ Twin Carbide Wearbars (Each)		
4.5" Carbide	5639-251	
6" Carbide	5639-252	
9" Carbide	5639-253	
Staggered Wearbars (Each)		
4" Carbide (RH) 3-Bolt	2603-988	
4" Carbide (LH) 3-Bolt	2603-989	
Steel Ski Wearbars	AFS (4-Bolt)	AWS (3-Bolt)
7/16-in. Diameter Round Host Bar (Pair)		
Hardweld Wearbar		1639-784
4-in. Carbide With Hardweld	0638-399	4639-013
6-in. Carbide With Hardweld	0638-520	

Bulk Pack Wearbars

Our most popular 4", 6", and 8" accessory carbide wearbars are available in bulk packaging, 10 pairs with nuts to a box. These are the same wearbars that we offer in Arctic Cat packaging. Bulk packaging allows Arctic Cat to offer you ultra-competitive pricing on these high volume wearbars.

Description	p/n
Wearbars For Arctic Cat '05-'12 Saddleless Skis; '03-'06 FC, SC; '02-'06 ZR	
10 Pairs 3639-310 - 4" Carbide With Hardweld	2639-184
10 Pairs 3639-311 - 6" Carbide With Hardweld	2639-185
10 Pairs 3639-312 - 8" Carbide With Hardweld	2639-186
Wearbars for ZR Style Parabolic, and Deep Snow Plastic Skis	
10 Pairs 3639-978 - 4" Carbide With Hardweld	3639-979
10 Pairs 1639-521 - 6" Carbide With Hardweld	2639-189

Stud Quantity/Inches of Turning Carbide

Sled	Trail	Performance
50-75 HP	48/4 in.	48/6 in.
75-125 HP	102/6 in.	153/8 in.
125-150 HP	153/8 in.	153/10 in.
150-170 HP	153/8 in.	153/10 in.



STEEL SKI WEARBAR APPLICATIONS

HARDWELD WEARBAR

Application	Year	p/n
4-Stroke Trail	'02	1639-744
4-Stroke Touring	'02	1639-744
BC 340	'97-'01	0639-198
	'00	1639-744
	'95-'99	1639-784
BC 440	'99-'00	0639-198
	'97-'98	1639-784
BC 550	'98-'02	0639-198
Cheetah Touring	'92-'93	1639-784
Cheetah 340, 440, 550	'94	1639-784
Cougar, Cougar 2-Up	'92-'98	1639-784
Cougar Dlx	'98	0639-198
EXT	'91-'98	1639-784
EXT Dlx	'98	0639-198
EXT Special	'91	1639-784
EXT 600	'97-'98	1639-784
EXT 600 Touring	'98	0639-198
FC	'03	3639-309
Jag	'92-'99	1639-784
Jag AFS L/T	'92-'93	1639-784
Jag Liquid	'96	1639-784
Jag Special	'91	1639-784
Lynx	'92-'93	1639-784
MC	'01-'04	0639-198
PTA 550	'02-'03	1639-744
PTA 660	'02-'03	0639-198
PTA 800	'02	0639-198
PTA	'91-'01	0639-198
	'91-'96	1639-784
PA	'00-'05	1639-744
	'92-'99	1639-784
PE	'97-'98	0639-198
PS	'96-'00	0639-198
Prowler	'91-'95	1639-784
	'90	1639-784
Prowler Special	'91	1639-784
Puma	'94-'97	1639-784
TC	'97-'02	0639-198
	'93-'95	1639-784
WC	'95-'96	1639-784
	'91	1639-784
WC EFI (AFS)	'91-'92	1639-784
Z 370	'99-'05	1639-744
Z 440	'00-'02	1639-744
	'97-'99	0639-198
Z 570	'02-'05	1639-744
ZL	'97-'03	0639-198
ZR	'97-'01	0639-198
ZR 440	'96-'99	0639-198
ZRT	'96-'02	0639-198

Application	Year	4" Carbide With Hardweld p/n	6" Carbide With Hardweld p/n
AFS	'91 & older	0638-399	0638-520
BC 340	'95-'99	0638-399	0638-520
BC 440	'95-'98	0638-399	0638-520
BC 550	'95-'97	0638-399	0638-520
Cheetah Touring	'86-'91	0638-399	0638-520
	'92-'93	4639-013	
Cheetah	'94	4639-013	
Cougar	'86-'91	0638-399	0638-520
Cougar, Cougar MC	'92-'97	4639-013	
El Tigre	'86-'89	0638-399	0638-520
EXT, EXT MC	'89-'91	0638-399	0638-520
	'92-'97	4639-013	
EXT Special	'91	4639-013	
	'92	0638-399	0638-520
EXT MC	'94-'96	0638-399	0638-520
EXT 580 Z	'93	0638-399	0638-520
EXT 600	'97-'98	4639-013	
Jag, Jag Deluxe	'92-'97	4639-013	
Jag AFS	'89-'91	0638-399	0638-520
Jag AFS LT	'90-'91	0638-399	0638-520
Jag Special	'91	4639-013	
	'92	0638-399	0638-520
Jag Z	'93-'94	0638-399	0638-520
Lynx	'91	0638-399	0638-520
	'92-'93	4639-013	
PTA	'86-'90	0638-399	0638-520
	'91-'96	4639-013	
PA	'90-'91	0638-399	0638-520
	'92-'99	4639-013	
Prowler, Prowler MC	'90	0638-399	0638-520
	'91-'95	4639-013	
Prowler Special	'91	4639-013	
	'92	0638-399	0638-520
Puma, Deluxe, 2-Up	'94-'97	4639-013	
TC	'93-'96	4639-013	
TC MC	'94-'95	4639-013	
WC, WC MC	(AFS) '91-'92	4639-013	
	(AWS) '92-'94	0638-399	0638-520
	'95-'96	4639-013	
Z 440	'95-'96	0638-399	0638-520
ZR 440	'93-'94	0638-399	0638-520
ZR 580, 700 (Steel Ski)	'93-'96	0638-399	0638-520

4 Bolt Wearbar; 0638-399, 0638-520
3 Bolt Wearbar; 4639-013

Traction & Control

2012 TRACK LUG HEIGHTS AND RECOMMENDED STUD LENGTH

Model	Track Length/ Lugs	Woody's Stud Length	Stud Boy Stud Length	Model	Track Length/ Lugs	Woody's Stud Length	Stud Boy Stud Length
Single-Ply Tracks				2-Ply Tracks			
Bearcat 570	151" x 1.250"	1.325	1.375	F 800, 1100 LXR	128" x 1.000"	1.075	1.080
Bearcat 570 XT, Z1 XT	154" x 1.375"	1.450	1.500	F 1100 Turbo LXR	128" x 1.250"	1.325	1.375
XF 800, 1100 LXR (Inc Turbo)	141" x 1.352**	1.325	1.375	F 800, 1100 SP (Inc Turbo)	128" x 1.250"	1.325	1.375
XF 800, 1100 SP (Inc Turbo)	141" x 1.600"	N/A	N/A	Sno Pro 500	128" x 1.000"	1.075	1.080
				T570, TZ1, TZ1 LXR	144" x 1.000"	1.075	1.080
				TZ1 Turbo LXR	144" x 1.352**	1.325	1.375

* Cobra 1.352" tracks have a standard lug height of 1.25". The overall lug height including the extended "towers" is 1.352". Because the "towers" will flex, Cobra 1.352" tracks use the same length studs as 1.25" track.

CAUTION

- To protect the tunnel from possible damage from the studs, install a Tunnel Protector Kit (see page 53) on models not so equipped. Do not use longer than recommended studs. Use only Arctic Cat approved Stud Templates shown on page 53.
- For Stud Length 1.325" and longer, we recommend the use of a Big Nut or Power Tower Support Nut.
- A short snowflap is required when installing studs on '07-'09 F Series, JR, Z1, and '09 CF (see page 53).
- Do not stud the original 1.250" track on the '06-'08 BC WT Turbo. Damage to the heat exchangers may occur. If you wish to install studs on '06-'08 BC WT Turbo track, the original 1.250" track must be replaced with a 1.00" track.

Single-Ply Track Application

■NOTE: '09-'12 Track applications shown on page 45.

WARNING

When installing studs on a single ply track, it is important to use Arctic Cat-approved studs (proper head diameter). If approved studs (proper head diameter) are not used, studs could tear free of the track causing possible injury or even death.

WOODY'S

A. Page 127

GRAND MASTER™ TRACTION KITS

60° Carbide Tip, 5/16" Thread, 1.20" Head.

Application	Qty	p/n
'09 F Series Sno Pro, Z1 Turbo LXR, Z1 Turbo Sno Pro; '10 Sno Pro 500 128" x 1.25"		
Grand Master Stud Kit (1.325" Studs)	102/pk	5639-230
Grand Master Stud Kit (1.325" Studs)	153/pk	5639-231
'12 XF 800 LXR, XF 1100 LXR (Inc. Turbo); '09-'11 CF 141" x 1.352"		
Grand Master Stud Kit (1.325" Studs)	94/pk	5639-144
'11-'12 BC XT 154" x 1.375"		
Grand Master (1.450" Studs)	108/pk	5639-626

GRAND MASTER™ STUDS

60° Carbide Tip, 5/16" Thread, 1.20" Head.

Description	Qty	p/n
1.325" With Big Nut	500/pk	5639-426

GRAND MASTER™ SUPPORT PLATES

Description	Qty	p/n
Single, Square 1.50" - 5/16"	500/pk	5639-427
Double - 5/16"	51/pk	5639-486

2-Ply Track Application

ARCTIC CAT TRACTION BY



B. Page 127

SIGNATURE SERIES STAINLESS STEEL

60° Carbide Tip, 5/16" Threads, 15/16" Head. Support Plates sold separately.

Description	Qty	p/n
1.075 With Nyloc Nut	102/pk	3639-915
	153/pk	4639-739
	1000/pk	3639-917
1.175 With Nyloc Nut	102/pk	3639-919
	153/pk	4639-740
	1000/pk	3639-921
1.325 With Big Nut	102/pk	3639-923
	153/pk	4639-741
	1000/pk	3639-925
1.450 With Big Nut	102/pk	3639-927
	153/pk	4639-742
	1000/pk	3639-929

C. Page 127

GOLD DIGGER® TRACTION MASTER®

60° Carbide Tip, 5/16" Threads, 1" Head. Support Plates sold separately.

Description	Qty	p/n
1.075 With Nyloc Nut	102/pk	3639-067
	153/pk	4639-748
	1000/pk	1639-118
1.175 With Nyloc Nut	102/pk	3639-069
	153/pk	4639-749
	1000/pk	1639-958
1.325 With Big Nut	102/pk	3639-362
	153/pk	4639-750
	1000/pk	1639-519
1.450 With Big Nut	102/pk	5639-913
	153/pk	5639-914
	1000/pk	5639-915



D. Page 127

BIG NUT

These aluminum nuts provide extra strength and are recommended when using studs 1.325" and longer.

Description	Qty	p/n
Short - 1.325" Studs	102/pk	4639-736
	153/pk	4639-737
	1000/pk	4639-738
Tall - 1.450" Studs	102/pk	4639-794
	153/pk	4639-795
	1000/pk	4639-796



Page 127

TRACTION KITS

Includes Studs, Support Plates, Standard or Big Nuts, Template, Drill, and Track Marker.

CAUTION

CF, CFR require Tunnel Protector Kit (see page 53).

Application	Qty	p/n
'12 F 800 Sno Pro, F 1100 Sno Pro, F 1100 Turbo LXR, Sno Pro; '10-'11 F Series Sno Pro, Z1 Turbo LXR, Sno Pro 128" x 1.25"	102/pk	5639-781
	153/pk	5639-782
'12 F 800 LXR, F1100 LXR; '07-'11 F Series; '09-'11 CFR, Z1, Z1 Turbo; '11-'12 Sno Pro 500 128" x 1.00"	102/pk	4639-550
	153/pk	4639-551
'06-'08 CF 136" x 1.25"	108/pk	4639-340
	162/pk	4639-341
'08-'10 Sno Pro 600	94/pk	4639-948
	128/pk	5639-383
'11 Sno Pro 600	90/pk	5639-637



Page 128

A. DIGGER SUPPORT PLATES

Description	Qty	p/n
Square 1.250" - 5/16"	102/pk	3639-093
	153/pk	4639-752
	1000/pk	0639-907
Round 1.375" - 5/16"	102/pk	3639-091
	153/pk	4639-751
	1000/pk	3639-005

B. DIGGER COLORED SUPPORT PLATES

Description	Color	Qty	p/n
Square 1.250" - 5/16"	Black	102/pk	4639-257
		153/pk	4639-753
		1000/pk	4639-259
	Green	102/pk	3639-388
		153/pk	4639-754
		1000/pk	2639-857
	Orange	102/pk	3639-390
		153/pk	4639-755
		1000/pk	2639-861

2-Ply Track Application

ARCTIC CAT TRACTION BY



Page 128

DOUBLE DIGGER™ SUPPORT PLATES

Description
5/16"

Qty p/n
12/pk 2639-134
48/pk 2639-135

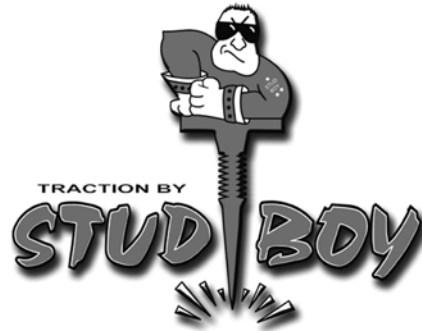

Woody's Limited Warranty

International Engineering & Manufacturing, Inc. warrants each product manufactured by it to be free from defects in material and workmanship under use for the purpose for which it is intended. The Company shall not be liable for damage or delays caused by defective materials or workmanship; is limited to the repair or replacement at its factory of defective article or part thereof, which may be returned to the factory, transportation charges, prepaid within one (1) year after delivery to the original purchaser. Proof of purchase is also required. The Company shall be the sole judge of the existence of any defect in the article so returned. No claims for charges incurred in the removal, disassembly or reinstallation of such article shall be allowed. Product manufactured for consumer use on snowmobiles is designed for snow or ice only, use on any other surface voids warranty.

This Warranty shall not cover any article which has been misused or neglected or damaged by accident or any article which has been altered outside the Company's factory. The Warranty for studs is void unless the studs are installed with Woody's installation tools, support plates and lock nuts; according to the recommendations set forth in Woody's Instructions and Template Patterns. This Warranty does not cover bending, chipping, flaking or carbide pin breakage or pin loss from stud wear, stud replacement labor or shipping.

The Company shall, in no event be liable for consequential damage or contingent liability arising out of any total or partial failure to function of any article manufactured by it or of any equipment on or in which it is used. Failure of a user to give notice to claim as to defect claimed under the provisions of the Warranty within one (1) year after delivery to original use, such claim shall constitute a waiver by consumer of all claims with respect to goods and equipment.

No express, implied, or statutory warranty other than that herein set forth is made or authorized to be made by the Company. All returned warranties will not be accepted without a return authorization number.

Woody's® Team Woody's®, Snowmobiler Logo, Traction Master, Flat-Top, Gold Digger, Mega-Bite, Excel, Chisel Tooth, Square Digger, Round Digger, Double Digger, Road Runner, Star Stud, Top-Stock, Extender Trail III, Trail Blazer IV, Executive, and Ultra Series are trademarks and/ or trade names of International Engineering and Manufacturing, Inc. Traction Master refers to a patented product of International Engineering & Manufacturing, Inc. and is covered by US Patent No. 5,23,266 and Canadian Patent No. 2,086,186. Woody's® Mega-Bite studs are covered by US Patent No. D415, 954 and Canadian Patent No. 88,613. Woody's® Universal Template is Patent Pending.

Woody's® Manufacturer Warranty Returns

Call our customer service department for a Return Authorization Number. This number must be visible on the outside of the box. The product must be inspected by a Woody's technician to determine if the product is defective due to material, quality or workmanship before a final warranty determination is made. Proof of purchase is required. All returns to the manufacturer are for exchange only.



Page 128

POWER POINT™

60° Carbide Tip, 5/16" Thread, 1" Head. Support Plates sold separately.

Description

1.080 With Nyloc Nut
1.375 With Nyloc Nut
1.500 With Nyloc Nut

Qty p/n
102/pk 5639-072
153/pk 5639-073
102/pk 5639-078
153/pk 5639-079
102/pk 5639-081
153/pk 5639-082



Page 128

POWER PLATE™ BACKERS

Description

Square 1.270" - 5/16"

Qty p/n
102/pk 5639-093
153/pk 5639-094
1000/pk 5639-095

2-Ply Track Application

Page 128

POWER POINT™ TRACTION KITS

Application	Qty	p/n
'12 F 800 Sno Pro, F 1100 Sno Pro, F 1100 Turbo LXR, Sno Pro; 10-'11 F Series Sno Pro, Z1 Turbo LXR, Sno Pro 128" x 1.25"	102/pk	5639-783
Power Point (1.375" Studs)	153/pk	5639-784
'12 F 800 LXR, F 1100 LXR; '07-'11 F Series; '09-'11 CFR, Z1, Z1 Turbo; '11-'12 Sno Pro 500 128" x 1.00" Track	102/pk	5639-099
Power Point (1.080" Studs)	153/pk	5639-100
'08-'12 T570, TZ1 144" x 1.00" Track	114/pk	5639-146
Power Point (1.080" Studs)		
'08-'10 Sno Pro 600		
Sno Cross (1.875" Studs)	96/pk	4639-947
Cross Country (1.375" Studs)	153/pk	5639-325
'11 Sno Pro 600		
Sno Cross (1.875" Studs)	90/pk	5639-636



Page 129

SUPER-LITE PLUS BACKERS

Single-Ply and 2-Ply application

Description	Color	Qty	p/n	
1.450" x 5/16"	Black	102/pk	5639-362	
		153/pk	5639-363	
		1000/pk	5639-364	
	Green	102/pk	5639-366	
		153/pk	5639-367	
		1000/pk	5639-368	
	Orange	102/pk	5639-370	
		153/pk	5639-371	
	White	1000/pk	5639-372	
		102/pk	5639-443	
			153/pk	5639-444

Stud Boy Limited Warranty

Liberty Products, Inc. warrants each product manufactured by it to be free of defects in workmanship and material while used for the purpose for which it is designed. Liberty Products, Inc. shall not be liable for damages or delays as a result of defects caused by defective workmanship or materials. Warranty is limited to the repair or replacement at Liberty Products of any defective part or product, within one (1) year of the delivery to the original purchaser, proof of purchase must accompany the product returned (freight prepaid). Liberty Products, Inc. shall be the sole judge of any defect, which might be claimed on the returned product. No other charges may be claimed in conjunction with the removal, reinstallation of such product. These products are designed and manufactured for use on snowmobiles on snow and ice only, use on other surfaces voids warranty. Warranty will be void if product has been mis-used, neglected, damaged or modified outside of Liberty Products, Inc. Does not cover bending, chipping, flaking or carbide breakage or loss from wear. Liberty Products, Inc. will not be liable for consequential damage or contingent liability arising from any total or partial failure to function of any product manufactured by it or any equipment on or in which it is used. No further warranty of any type is intended or implied or will by authorized to be made by Liberty Products, Inc.



Page 129

POWER TOWER SUPPORT NUTS

Recommended when using studs 1.375" and longer.

Description	Qty	p/n
.750"	102/pk	5639-096
	153/pk	5639-097
	1000/pk	5639-098



Page 129

STUD DRILL

Description	p/n
5/16"	1639-629



Page 129

TRACK MARKER

Description	p/n
Track Marker	1639-520

Page 129

STUD TEMPLATES

Application	p/n
'12 F5, F570, F 800, F 1100, F 1100 Turbo; '11-'12 Sno Pro 500;	4639-443
'07-'11 F Series; '09-'11 CFR, Z1 128-in. (2-Ply)	
'12 XF 800 LXR, XF 1100 LXR (Inc Turbo); '09-'11 CF 141-in. (Single-Ply)	4639-991
'08-'12 T570, TZ1, TZ1 LXR; '10-'11 Z1 Turbo EXT; '11 F8 EXT 144-in. (2-Ply)	5639-160
'11-'12 BC XT 154-in. (Single-Ply)	5639-609
'09-'10 BC XT 156-in. (2-Ply); '10-'12 BC 570 151-in. (Single-Ply)	5639-461
'09 F Series Sno Pro, Z1 Turbo LXR, Sno Pro; '10 Sno Pro 500 128-in. (Single-Ply)	5639-428
'06-'08 CF 136-in. (2-Ply)	4639-344
All Purpose 15" x 121" Tracks (2-Ply)	4639-488
All Purpose 13.5" Tracks (2-Ply)	3639-589

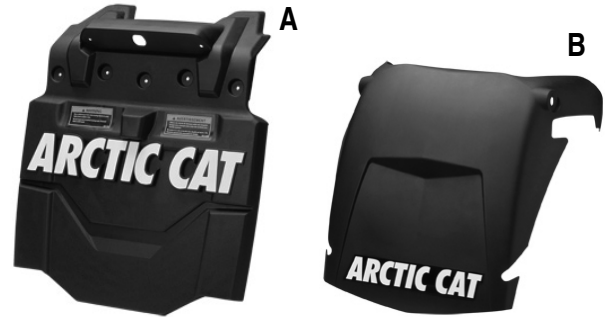

Page 129

SHORT SNOWFLAP

Required when installing studs on the models listed below.

Application	Year	p/n
(A) CF, CFR	'09-'11	5639-232
(B) F Series	'07-'09	4706-462
(B) JR	'07-'08	4706-462
(B) Z1, Z1 Turbo	'09	4706-462



Page 129

TUNNEL PROTECTOR KIT

Required when installing studs on the models listed below. On liquid-cooled models not listed, the heat exchanger acts as a tunnel protector. Be sure not to install studs in line with the heat exchanger.

Application	Year	p/n
F 800, F 1100, F 1100 Turbo	'12	5639-668
XF 800, XF 1100, XF 1100 Turbo	'12	5639-752
CF, CFR	'09-'11	4639-968
BC 570	'09-'12	4639-771
BC Z1 XT	'09-'12	5639-143
CF	'06-'08	4639-338
F570, T570	'08-'12	4639-771
M Series, M8 HCR	'09-'11	5639-268

Oil & Care

2012 MODEL YEAR SNOWMOBILE OIL APPLICATION CHART

Model	0W-40	APV	Formula SS	Formula 50	Capacity
120	X				20.3 U.S. oz
Sno Pro 500		X	X	X	2.75 U.S. Qt
Bearcat 570/ F570/T570				X	4.2 U.S. Qt
Bearcat 570 XT				X	4.8 U.S. Qt
F 800/M 800/XF 800 Models		X	X		3.9 U.S. Qt
F 1100/M 1100/ XF 1100 Models	X				3.28 U.S. Qt
Bearcat Z1/TZ1 Models	X				4.0 U.S. Qt

Visit www.arcticcatlubricants.com for more oil information.



Page 130

APV SYNTHETIC OIL

Our APV Synthetic Oil stands alone as the best, most performance oriented lubrication that could possibly be put through your sled. The best oil for the dollar guarantees flawless engine operation.

Description	p/n
Quart	4639-349
Gallon	5639-469
2.5 Gallon	4639-347
16 Gallon Drum	2639-510
16 Gallon Drum (50th Anniversary)	5639-908
55 Gallon Drum	2639-509



Page 131

FORMULA SS SEMI-SYNTHETIC OIL

Formula SS Semi-Synthetic 2-cycle oil offers the benefits of a semi-synthetic formulation at a phenomenal value. Use in ALL Arctic Cat 2-cycle engines, including Arctic Power Valve engines.

Description	p/n
Quart	5639-470
Gallon	5639-471
2.5 Gallon	5639-472
16 Gallon Drum	5639-473
16 Gallon Drum (50th Anniversary)	5639-909
55 Gallon Drum	5639-474



Page 131

FORMULA 50 OIL

Mineral based 50:1 Injection Oil. High quality mineral base formulation, proven performance over time. Provides rust and corrosion protection. Mixes easily with fuel and all other Arctic Cat 2-cycle engine oils.

Description	p/n
Quart	5639-475
Gallon	5639-476
2.5 Gallon	5639-477
16 Gallon Drum	5639-478
16 Gallon Drum (50th Anniversary)	5639-910
55 Gallon Drum	5639-479



Page 131

SYNTHETIC 0W-40 OIL

Unique synthetic formulation designed and tested for use in Arctic Cat 4-Cycle Snowmobiles. Premium additive system provides superior cleanliness, anti-wear protection, and minimizes deposit formations.

Description	p/n
Quart	5639-172
Gallon	5639-173
16 Gallon Drum	5639-172
16 Gallon Drum (50th Anniversary)	5639-911
55 Gallon Drum	5639-175



Page 131

SYNTHETIC OIL CHANGE KIT

Application	p/n
'07-'12 1100 cc Models (Includes Turbo)	5639-174



EMPTY DRUM

Application
16 Gallon (50th Anniversary)

p/n
5639-907



Page 132

CHAIN LUBE

Description
8 oz.

p/n
4639-363



Page 132

SYNTHETIC TRANSMISSION LUBE

Description
12 oz.

p/n
5639-039



Page 132

SYNTHETIC ACT GEARCASE FLUID

Description
3 oz. ACT Non-Reverse
12 oz. ACT w/Reverse
15 oz. ACER (Engine) Reverse
Gallon

p/n
4639-361
4639-628
5639-219
5639-632



Page 132

ARCTIC CAT TRANSMISSION LUBE

Description
12 oz.
2.5 Gallon

p/n
4639-364
1639-247



Page 132

ACT FLUSH FLUID

Description
6 oz.
Gallon

p/n
4639-333
5639-847



Page 132

SYNTHETIC CHAIN LUBE

Description
8 oz.

p/n
5639-038



Page 132

SYNTHETIC SHOCK OIL

Description
Lt Wt - Quart
Med/Lt Wt - Quart
Med Wt - Quart

p/n
4639-367
4639-369
4639-368



Page 132

SEMI-SYNTHETIC SHOCK OIL

Description
Quart

p/n
5639-530



Page 133

FUEL STABILIZER

Description
8 oz.

p/n
0436-907



Page 132

ARCTIC CAT SHOCK OIL

Description
Quart

p/n
4639-366



Page 133

DOT 4 BRAKE FLUID

Description
12 oz.

p/n
5639-848



Page 133

ARCTIC CAT ANTIFREEZE

Description
Gallon

p/n
0436-909



Page 133

FUEL INJECTOR & CARBURETOR CLEANER

Description
12 oz.

p/n
0436-904



Page 133

FUEL DE-ICER

Description
12 oz.

p/n
0436-906



Page 133

ENGINE PRESERVER

Description
12 oz.

p/n
0436-888



FOX FLOAT FLUID

Specially made for use in the air chamber of FOX FLOAT Air Shox.

Description p/n
8 oz. 4639-012



HOOD & WINDSHIELD CLEANER/POLISH

Description p/n
8 oz. 4639-559



Page 133

ARCTIC CAT ALL-TEMP GREASE

Description p/n
14 oz. 4639-365

MISCELLANEOUS GREASE

Description p/n
Throttle Cable Lube .5 oz. 1056-053
Electric Start 2 cc 1056-272
High Temperature .5 oz. 1056-077
Dielectric 2.7 oz. 1056-287



CHAIN LUBRICANT

Description p/n
12 oz. 0436-903



HIGH OCTANE RACE FUEL

Description p/n
110 Octane Race Fuel
16 Gallon Drum 2639-098
55 Gallon Drum 2639-097

116 Octane Race Fuel p/n
16 Gallon Drum 3639-620
55 Gallon Drum 3639-621



Page 133

CAT CLEANER

Description p/n
22 oz. 4639-371

DRUM PUMP (NOT SHOWN)

Application p/n
16 to 55 Gallon Drums 1639-249



VEHICLE WASH/CLEANER

Description	p/n
Gallon	4639-631
5 Gallon	4639-630
30 Gallon	4639-629



LEATHER CLEANER/CONDITIONER

Description	p/n
Leather Cleaner/Conditioner	4912-051



ALL PURPOSE CLEANER

Description	p/n
Gallon	4639-634
5 Gallon	4639-633
30 Gallon	4639-632



LEATHER WATER REPELLENT

Description	p/n
Leather Water Repellent	4912-052



HEAVY DUTY CLEANER/DEGREASER

Description	p/n
Gallon	4639-637
5 Gallon	4639-636
30 Gallon	4639-635



REVIVEX WATER & STAIN REPELLENT

Description	p/n
Revivex Water & Stain Repellent	4201-280

CLEANING KIT

Kit includes two gallons each of the following cleaners:
Vehicle Wash/Cleaner, All Purpose Cleaner, Heavy Duty Cleaner/Degreaser.

Description	p/n
Cleaning Kit	4639-666



WATER/STAIN REPELLENT

Description	p/n
Water/Stain Repellent	4912-152

General Maintenance



Page 134

SLED LIFT

Maximum lift capacity 625 lbs.

Description

- (A) Sled Lift (Ship wt. 65 lb)
- (B) Wheel Kit (Ship wt. 15 lb)

p/n
4639-992
4639-993

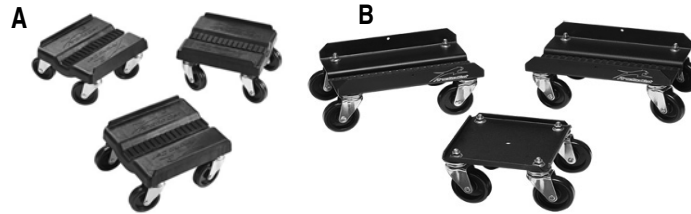

Page 134

CAT CADDY

Set of 3.

Description

- (A) Plastic - Black
- (A) Plastic - Green
- Replacement Wheel - Push-in (Each)
- (B) Aluminum - Black
- Replacement Wheel - Threaded (Each)

p/n
5639-873
5639-874
0641-264
4639-766
0641-535



Page 134

SLED SLIDES

Set of 3.

Description

- Steel - Green

p/n
5639-579



Page 134

JACK STAND

Description
33" High

p/n
4639-768



Page 135

FRONT END LIFT

Description
Front End Lift

p/n
5639-151



Page 135

HANDLEBAR STAND

Description
(A) Handlebar Stand
(B) Steering Post Stand

p/n
5639-152
5639-946



VERTICAL STEERING POST KIT

Application

'12-'13 F1100 Turbo, M 800 (Std), XF 1100, XF 1100 Turbo;
'12 M 1100, M 1100 Turbo, M 1100 Turbo HCR;
'13 M 1100 (Std), M 1100 Turbo (Std)

p/n

5639-945



Page 135

SHOP DOLLY

Added freight charges may apply.

Description

Shop Dolly
(Shipping: 46L x 25W x 11H, 70 lb)
Replacement Strap
Replacement Wheel (Each)

p/n

5639-373

5639-446

5639-514



Page 136

A. STANDARD TIE-DOWNS

1" x 69", 1,000-lb Rating

Sold in pairs.

Description

Black
Green

p/n

5639-411

5639-415

B. DELUXE TIE-DOWNS

1.125" x 78", 1,200-lb Rating

Sold in pairs.

Description

Black

p/n

5639-423

C. RATCHET TIE-DOWNS

1.125" x 102" 1,200-lb Rating. Sold in pairs.

Description

Black

p/n

5639-424



Page 136

A. TOW STRAP

Description

Tow Strap

p/n

4639-247

B. TOW ROPE

Description

Tow Rope

p/n

0636-577



Page 136

TOOL BAG

Description

Tool Bag

p/n

5639-834



Page 136

HEATED SHIELD ADAPTER

Application

Models with accessory outlet

p/n

5639-645



Page 136

RACING TAPE

2" x 60-yd. rolls.

Description

Black
Green
Orange

p/n

4639-579

4639-580

5639-103



Page 136

TOUCH-UP PAINT

Description	Application	1/2 oz.	12 oz.
Hood Paint			
Black (Gloss)	Black Hoods	0652-100	0652-022
Apple Green Metallic	'10 F Series LE, TZ1 Turbo LE, Z1 Turbo LE	0652-152	0652-153
Cat Green	'00-'04 ZR; '01-'04 Z; '03-'04 FC; '04 MC	0652-099	0652-067
Copper	'09 F Series LE, TZ1 Turbo LE, Z1 Turbo LE	0652-139	0652-140
Desert Red Metallic	'11-'12 TZ1 LXR, TZ1 Turbo LXR, BC Z1 XT LTD	0652-160	0652-161
Navy Blue	'10 TZ1 LXR, TZ1 Turbo LXR	0652-154	0652-155
Orange * (Top Coat)	'04-'06 KC; '05-'06 FC; '06-'07 Z; '05-'08 M; '06-'08 CF; '07-'08 F Series; '11 CF SP	0652-105	0652-106
Pearl Cat Green	'05-'06 FC, SC, Z, ZR; '05-'07 M; '06-'07 CF; '09-'11 M8 HCR	0652-115	0652-117
Pearl White (Top Coat)****	'12 F, M, XF Ltd	0652-175	0652-176
Pearl White (Base Coat)	'12 F, M, XF Ltd	0652-181	0652-182
Pink **	'09-'10 Accessory Kit	0652-137	0652-138
Sublime Green***	'11 M8 LTD, CF LTD, F8 LTD, Z1 Turbo LTD	0652-164	0652-165
White Metallic * (Top Coat)	'08-'11 M Series SP; '11 CFR, TZ1 LXR, TZ1 Turbo LXR	0652-133	0652-134
Gold Metallic (Top Coat)		0652-173	0652-174
White (Base Coat)		0652-119	0652-120
Clear (Top Coat) (12-oz. Overspray Leveler)		0652-109	0652-166

* Metallic Top Coat only. You must first apply White (Base Coat) before applying color.

** Pink 1/2 oz. (p/n 0652-137) consists of a Base Coat and a Top Coat.

Pink 12 oz. (p/n 0652-138) requires White (Base Coat) (p/n 0652-120).

*** Sublime Green (Base Coat) requires the use of Gold Metallic

Top Coat.

**** Metallic Top Coat only. You must first apply Pearl White (Base Coat) before applying color.

Metal Paint		1/2 oz.	12 oz.
Black	Metal Parts	0652-110	0652-024
Cat Green	'98-'11	0652-111	0652-077
Orange	'08-'12	0652-141	0652-142
Orange Metallic (Top Coat)*****	'12 F, M, XF Ltd	0652-183	0652-184
Orange Metallic (Base Coat)	'12 F, M, XF Ltd	0652-179	0652-180
Pearl Cat Green	'08-'12	0652-144	0652-145
Pearl White (Top Coat)****	'12 F, M, XF Ltd	0652-177	0652-178
Pearl White (Base Coat)	'12 F, M, XF Ltd	0652-181	0652-182
Platinum	'02-'12	0652-112	0652-096
Black	High Temp		0652-052

**** Metallic Top Coat only. You must first apply Pearl White (Base Coat) before applying color.

***** Metallic Top Coat only. You must first apply Orange Metallic (Base Coat) before applying color.

■NOTE: Models not listed have non-paintable, color-molded plastic.



Page 137

CTEK BATTERY MAINTAINER

Description	p/n
12V 800 mA (Includes leads A, B, & D on this page)	5639-418



Page 137

CTEK BATTERY CHARGER/MAINTAINER

Description	p/n
12V 3.3 amp (Includes leads A, B, & D on this page)	5639-419

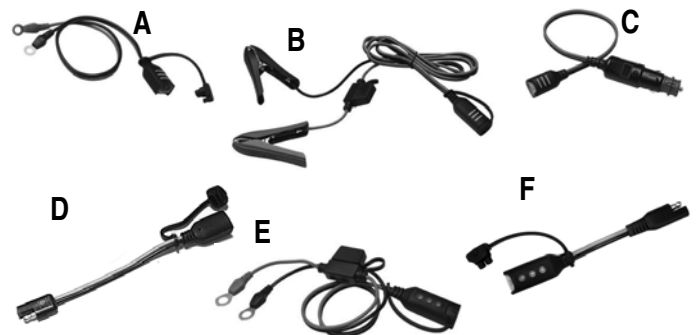

Page 137

CTEK BATTERY LEADS

■NOTE: Comfort Indicators feature a three LED battery condition indicator.

Description	p/n
(A) Ring Terminals	5639-420
(B) Alligator Clips	5639-421
(C) Outlet	5639-422
(D) Style 21 Adapter	5639-484
(E) Comfort Indicator - Ring Terminals	5639-485
(F) Comfort Indicator - Style 21	5639-397



YUASA BATTERY MAINTAINER

Description
12V 900 mA **p/n**
4639-998



YUASA BATTERY LEADS

Description
(A) Ring Terminals **p/n**
5639-162
(B) Alligator Clips **p/n**
5639-163



ACCESSORY ADAPTER

Description
2-Outlet **p/n**
1639-623
3-Outlet **p/n**
1639-624



DRIVE BELT HOLDER

Description
Drive Belt Holder **p/n**
0636-659

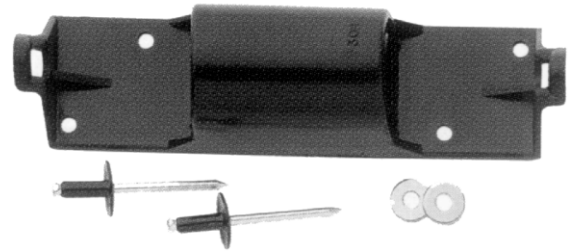

RIVET-MOUNTED PLUG HOLDER

Description
Plug Holder **p/n**
4639-549



SPARK PLUG CADDY

Description
Green **p/n**
1639-618



TEMPERATURE GAUGE

Application
'99-'07 LC Models Except CF, F, FC, JR, M, SC, 4-Stroke **p/n**
1639-217

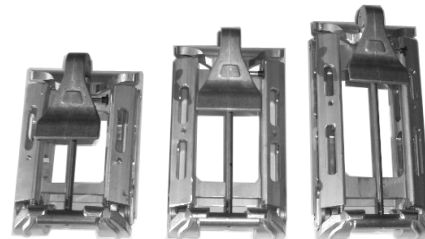

HANDLEBAR RISER KIT

Fits '07-'11 F Series Sno Pro; '09-'11 CFR, Z1
Description
4" **p/n**
4639-599
5" **p/n**
4639-600
6" **p/n**
4639-601

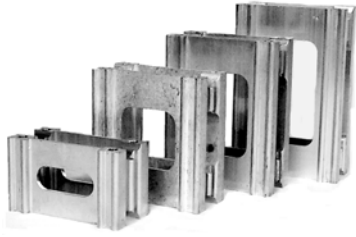

HANDLEBAR RISERS

Fits '02-'06 ZR; '03-'06 FC; '07-'11 F Series (Std)

Description	p/n
2.44"	0605-514
3.00"	0605-884
4.44"	0605-513
5.44"	0605-491
6.44"	0605-512

■NOTE: If 6.44" Riser Block (p/n 0605-512) is used on an '05-'06 FC with ACT Drive, it is necessary to install a longer Brake Line (p/n 1602-588).



WHEEL KIT

Application	p/n
'08-'10 Sno Pro 600	4639-964



HOOD LATCH REPAIR KIT

Includes two pins.

Application	p/n
'05-'11 CF, CFR, M Series	5639-498



HORN KIT

Application	p/n
'08 JR; '08-'11 F Series (Liquid-Cooled), TZ1; '09-'11 Z1 (Non-Turbo)	4639-857

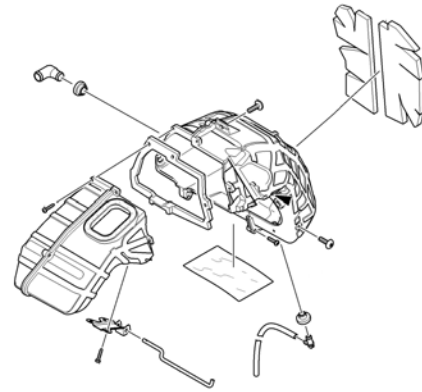

SPLIT AIRBOX KIT

Two-piece design provides easier access to engine components.

Application	p/n
'07-'08 JR; '08-'11 TZ1; '09-'11 BC Z1 XT, Z1	5639-934



CLUTCH FAN KIT

Includes fan and mounting hardware

Application	p/n
'12 F, XF	5639-922



NGK® SPARK PLUGS

Arctic Cat ATV and Snowmobile applications in **BOLD**.

Description	p/n	Description	p/n
Iridium Spark Plugs			
BR8EIX	0217-735		
BR9EIX	0217-729		
BR10EIX	0217-804		
CR6EIA-9	0217-733		
CR7EIX	0217-734		
DR7EIX	0217-736		
MR8AI-9	0217-806		
Standard Spark Plugs			
AB7	0217-728	BR9ECS-5	0217-786
AB8	0217-808	BR9ES (SCREW CAPS)	0217-035
B2LM	0217-778	BR9ES (SOLID CAPS)	0217-700
B4LM	0217-770	BR9EYA	0217-709
B6L	0217-789	BR9HS-10	0217-756
B6S	0217-765	BR10ES (SOLID CAPS)	0217-634
B7HS	0217-044	BR10EYA	0217-714
B8ES	0217-029	BU8H	0217-744
B8HS	0217-043	BUHW	0217-751
B9ES	0217-015	BUHW-2	0217-750
B9HS-10	0217-791	CMR7A	0217-776
BKR6EJU	0217-793	CPR8E	0217-799
BM7A	0217-781	CR6E	0217-632
BMR4A	0217-767	CR6HS	0217-792
BMR6A	0217-753	CR6HSA	0217-725
BP4HS	0217-761	CR7E	0217-708
BP5HS	0217-783	CR7HS	0217-788
BP8H-N-10	0217-746	CR7HSA	0217-726
BPM6A	0217-763	CR8E	0217-705
BPM7A	0217-749	CR8EK	0217-711
BPM7Y	0217-764	CR9E	0217-738
BPM8Y	0217-752	CR9EH-9	0217-766
BPMR4A	0217-772	CR9EK	0217-755
BPMR6A	0217-773	CR10EK	0217-787
BPMR7A	0217-741	D7EA	0217-795
BPR2ES	0217-747	D8EA	0217-796
BPR4ES	0217-809	D8HA	0217-794
BPR4HS	0217-785	D9EA	0217-784
BPR5ES	0217-704	DCPR6E	0217-779
BPR5HS	0217-702	DCPR7E	0217-717
BPR6ES	0217-807	DCPR8E	0217-774
BPR6EFS	0217-748	DP8EA-9	0217-782
BPR6HS	0217-777	DPR6EA-9	0217-754
BPR7HS	0217-716	DPR7EA-9	0217-730
BPR9ES	0217-762	DPR8EA-9	0217-737
BPZ8H-N-10	0217-769	DPR8Z	0217-775
BPZ8HS-10	0217-757	DPR9EA-9	0217-790
BR6FS	0217-742	DR7EA	0217-713
BR6HS	0217-027	DR8EA	3304-919
BR7ES	0217-745	DR8ES	0217-771
BR7HS	0217-768	DR8ES-L	0217-740
BR7HS-10	0217-758	IZFR5G	0217-759
BR8ES (SCREW CAPS)	0217-034	KR8AI	0217-719
BR8ES (SOLID CAPS)	0217-701	LFR5A-11	0217-760
BR8HS	0217-739	LFR6A-11	0217-780
BR8HS-10	0217-743	PZFR6H	0217-641

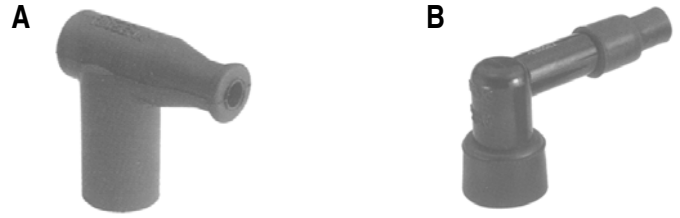

SPARK PLUG CAPS

Description

(A) Silicone Rubber - Black
(B) Standard Type - Black

p/n
3006-367
3003-175



RAIL BRACE KIT

Includes RH & LH rail braces and mounting hardware.

Application

M Series 153" & 162", XF 141"

Year	Color	p/n
'12	Black	5639-981
	Orange	5639-982
	Unpainted	5639-983
'09-'11	Unpainted	5639-242

M Series 153"

SPEEDOMETER/TACHOMETER

Application

'08-'11 Sno Pro 600

p/n
4639-960



HEAVY-DUTY HANDLEBAR

Includes grips and heating elements.

Application

'05-'10 Sno Pro 600

p/n
1705-155



THROTTLE LEVER BOLT KIT

Fits models with aluminum throttle block.

Application

'05-'10 Sno Pro 600

p/n
4639-336



FUEL PUMP REPAIR KITS

Description	p/n
Rectangular Mikuni	0636-272
Round Mikuni	0636-276
Square Mikuni	0636-640
Pentagon Mikuni	1639-191
ATP 2/3	2639-095

SILICONE GASKET MAKER

Excellent for sealing around belly pan area and air box seams.

Description	p/n
Ultra Black Silicone Gasket Maker 70 ml	1639-834

HIGH TEMP SILICONE SEALANT

This sealant is recommended for sealing the crankcase halves of all Suzuki liquid-cooled engines.

Description	p/n
High Temperature Silicone 90 ml	0636-069

ARCTIC CAT LOCTITE

Description	p/n
Loctite 242 Blue 10 ml	1639-814
Loctite 242 Blue 50 ml	1639-815
Loctite 263 Red 10 ml	5639-901
Loctite 263 Red 50 ml	5639-902
Loctite 271 Red 10 ml	1639-819
Loctite 271 Red 50 ml	1639-820
Loctite 290 Green Wicking 10 ml	1639-823
Loctite 290 Green Wicking 50 ml	1639-824
Loctite 609 Green Retaining 50 ml	1639-821
Loctite 620 Green Ret Hi Temp 10 ml	1639-826
Loctite 620 Green Ret Hi Temp 50 ml	1639-822

HANDLEBAR GRIP ADHESIVE

Description	p/n
Loctite 498 1 oz.	1048-058

CRANKCASE SEALANT

This sealant is highly recommended for sealing all Arctic Cat, Suzuki fan-cooled engine crankcase halves.

Description	p/n
Three-Bond Gasket Sealant	0636-070

CRANKCASE SEALANT - 4-STROKE

This sealant is recommended for Arctic Cat 4-Stroke engines.

Description	p/n
Sealant, 100 gram tube	1048-070

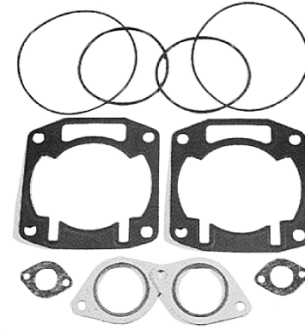

GASKET SETS

Application	Year	p/n
340 F/C Twin	'79-00	0636-128
370 F/C Twin	'99-08	1639-123
440 F/C Twin (Except those listed below)	'97-06	0639-441
440 F/C Twin ('99 Z 440; '00-'03 Z 440 Sno Pro)	'99-03	1639-605
440 F/C Twin	'80-96	0636-095
440 L/C Twin	'90-00	0636-635
	'78-89	0636-096
440 L/C Twin (ZR)	'93-95	0636-884
440 L/C Twin (Prowler Special)	'91-92	0636-884
440 L/C Twin w/Reed	'97-00	0639-224
500 F/C Twin (56 H.P.)	'86-91	0636-093
500 F/C Twin (48 H.P.)	'85-87	0636-094
500 L/C Twin, Non-APV "Laydown" (Sno Pro)	'04-'12	3639-539
500 L/C Twin, APV "Laydown"	'03-06	2639-972
500 L/C Twin, APV	'01-02	1639-988
500 L/C Twin, Non-APV	'98-02	0639-115
530 L/C Twin	'87-91	0636-097
	'86	0636-183
	'80-85	0636-098
550 L/C Twin	'91-05	0636-812
570 F/C Twin	'02-'12	2639-147
580 L/C Twin	'91-'04	0636-812
600 L/C Twin, APV "Laydown"	'04-09	3639-538
600 L/C Twin, APV	'01-03	1639-989
600 L/C Twin, Non-APV	'98-02	0639-115
600 L/C Triple, APV	'01-02	1639-990
600 L/C Triple	'95-00	0638-938
650 L/C Twin	'88-90	0636-409
660 L/C Triple (4-Stroke)	'03-08	3006-944
	'02	3006-296
660 L/C Triple (4-Stroke) Turbo	'05-'07	3006-961
	'04	3006-759
700 L/C Twin, APV "Laydown"	'03-06	2639-973
700 L/C Twin	'91-'96,	0636-813
	'99-00	
800 L/C Twin, APV "Laydown" (Power Up)	'10-'12	5639-520
	'07-'09	4639-664
800 L/C Twin, APV	'01-'04	1639-991
800 L/C Triple	'95-01	0638-205
900 L/C Twin, APV	'03-06	1639-991
900 L/C Triple	'93-97	0638-205
1000 L/C Twin, APV "Laydown"	'07-'12	4639-663
1000 L/C Triple	'98-02	0638-205
1100 L/C Twin (4-Stroke)	'07-'12	4639-619

ACT DRIVE GASKET SETS

Application	Year	p/n
CF, M Series	'08	2602-267
	'07	2602-191
F Series	'07-'08	2602-192

ACT DRIVE CASE SEALANT

This sealant is recommended for ACT drive cases.

Description	p/n
Sealant, 3-oz. tube	4639-030

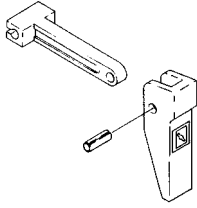

CHOKE LEVER REPAIR KIT

Application

Single or Dual Carburetor
Triple Carburetor
'01-'02 Triple Models

p/n

0636-062
0638-630
1639-835



OVERLOAD SPRING TOOL

Description

Overload Spring Tool

p/n

0744-022



TRACK CLIP TOOL

Description

Track Clip Tool

p/n

0644-194

FOX SHOCK REBUILD KITS

Description

IFP Shock
Front Arm Adjustable Shock
Clicker Shock
Float w/o Reservoir
Float w/Reservoir

p/n

1639-769
1639-770
1639-771
2604-796
2603-498

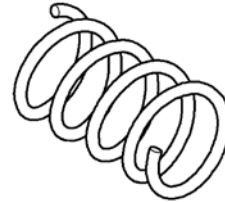

DRIVE CLUTCH SPRING

Provides smoother, lower RPM clutch engagement.

Application

'10-'12 800 cc Models

p/n

0646-252

Helmet Parts



TXI



EYEPORT FOAM PIECE

Description	p/n
'02-'11	
3/4"	4212-291
5/8"	4212-292



A



B

A. CHIN CURTAIN

Description	p/n
Chin Curtain	4212-290

B. CHIN VENT

Description	p/n
Chin Vent	4222-801
Chrome Chin Vent	4252-032



SIDE AND TOP VENT COVER KIT

Description	p/n
Vent Cover Kit	4222-800
Chrome Vent Cover Kit (Side Vents Only)	4252-033



RATCHET KIT

Description	p/n
Ratchet Kit	4212-919
Shield Screws Only (10/pkg)	4212-801



A



B

A. SHIELD

Description	p/n
Clear	4212-845
Smoke	4212-846
Yellow	4212-847
Silver Mirror	4222-740
Chrome Frame/Clear	4232-880
Chrome Frame/Smoke	4232-881
Chrome Frame/Yellow	4232-882
Chrome Frame/Silver Mirror	4232-883

B. ELECTRIC SHIELD KIT

Description	p/n
Electric Shield Kit	4212-848
Replacement Elec. Coil Cord	4202-922
Replacement Elec. Dash Cord	4202-923
Accessory Ext. Harness - 24"	1686-457
Replacement Elec. Shield Only	4212-849
Electric Shield Cord Converter (PFP coil cord to TXi dash)	4222-510
Electric Shield Cord Converter (TXi coil cord to PFP dash)	4222-511

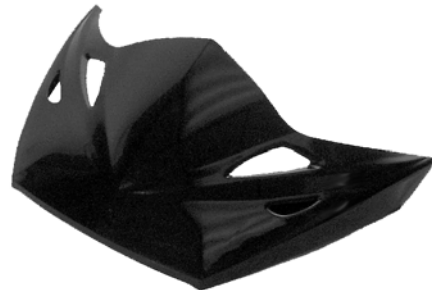

VISOR

Description	p/n
Black	4212-101
Chrome	4232-884
Visor Screws Only (12/pkg)	4222-803



PFP & PFP YOUTH

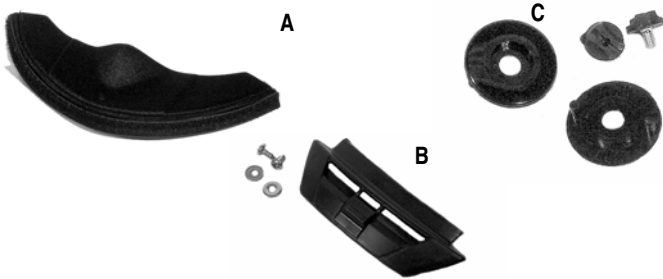

A. BREATH DEFLECTOR

Description
Breath Deflector

p/n
4982-765

B. CHIN VENT

Description
Chin Vent

p/n
4992-735

C. RATCHET KIT

Description
Ratchet Kit
Shield Screws Only (Metal Thread) 10/pkg

p/n
4912-122
4212-801



PFP II



RATCHET KIT

Description
Ratchet Kit
Shield Screws Only (10/pkg)

p/n
4982-762
4212-801

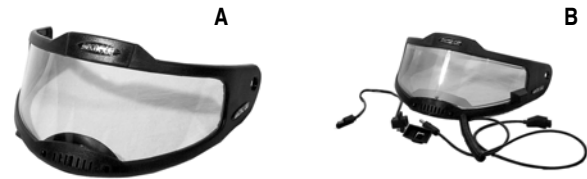

A. SHIELD

Description
Clear
Smoke

p/n
4972-463
4972-464



A. SHIELD

Description
Clear
Smoke
Amber/Yellow

p/n
4212-810
4212-811
4212-812

B. ELECTRIC SHIELD KIT

Description
Electric Shield Kit
Replacement Electric Coil Cord
Replacement Electric Dash Cord
Replacement Electric Shield Only
Electric Shield Cord Converter (PFP 2011 coil cord to TXi dash)
Electric Shield Cord Converter (TXi coil cord to PFP 2011 dash)
Accessory Ext. Harness - 24"

p/n
5222-500
4202-922
4202-923
5222-501
4222-510
4222-511
1686-457



TEAM ARCTIC (Model Moto X)

A. VISOR

Description
Black
Team Arctic Green Graphics (2012)
Team Arctic Black Graphics (2012)
Team Arctic Orange Graphics (2012)

p/n
5212-601
5222-390
5222-370
5222-380

B. BREATH DEFLECTOR

Description
Breath Deflector

p/n
5212-599



ATV OPEN FACE



VISOR

Description	p/n
Visor	4208-239



VISOR (2005-2011)

Description	p/n
Visor	4258-009



SNO-CROSS SNO PRO (Model Pro-X)

VISOR

Description	p/n
Black	5212-600
Sno Pro Orange Graphics (2012)	5222-400
Sno Pro Black Graphics (2012)	5222-360



SNO/ATV MX (Model 555)

A. VISOR

Description	p/n
Black	4242-950
Chrome	4252-017
Flat Black	4282-920
Visor Screws (10/pkg)	4212-801

B. FRONT VENT

Description	p/n
Front Vent	4242-951

C. TOP VENT COVER

Description	p/n
Top Vent Cover	4242-953

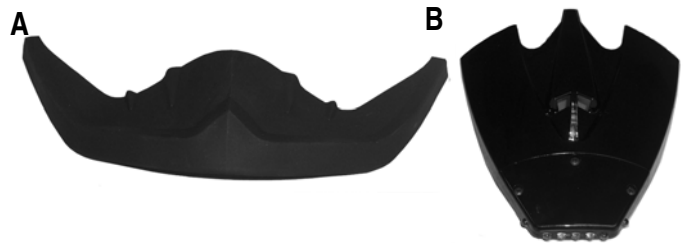

A. WINDGUARD

Description	p/n
Windguard	4242-954

B. TAILLIGHT

Description	p/n
Taillight	4242-952



CROSSTEC



SHIELD

Description

	p/n
(C) Electric Shield Kit ('02-'09)	4282-869
(C) Electric Shield Only ('02-'09)	4282-865
Electric Shield Coil Cord (Not Shown)	4202-922
Electric Shield Power Cord (Not Shown)	4202-923
Accessory Ext. Harness - 24"	1686-457
(A) Magnetic Power Cord	4262-907
(B) Crosstec/TXI Retrofit Headset Electric Shield Cord	4262-716
Clear Replacement Shield	4282-859
VRE Headset Electric Shield Cord (Not Shown)	4262-717
(D) Sun Shield - Smoke	4262-713
(D) Sun Shield - Yellow	4262-714
(D) Sun Shield - Orange	4262-715
Sun Shield Knob w/screw (Not Shown)	4272-997

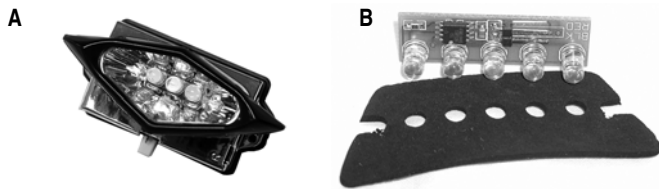

FRONT & REAR LED LIGHT

Description

	p/n
(A) Front Light Assy	4262-900
(B) Rear LED Light Assy	4262-901
(B) Rear Light Cover	4262-902



BREATH DEFLECTOR

Description

	p/n
Breath Deflector (XS-M)	4282-860
Breath Deflector (L-2XL)	4282-861



FRONT LIGHT LENS

Description

	p/n
Front Light Lens	4282-904
Light Button	4282-903



MIC & SPEAKERS

Description

	p/n
VRE Mic. Assy	4262-903
VRE Mic. Foam Assy	4262-904
Headset Speaker (Each)	4262-905



RATCHET KIT

Description

	p/n
(A) Ratchet Kit	4262-911
Ratchet Disc Set	4282-901
(B) Aluminum Shield Screws (Pair)	4262-910
(C) Top Ratchet Bar	4282-902



CHIN CURTAIN

Description
(A) Chin Curtain
(B) Extended Chin Curtain

p/n
4262-912
4282-900

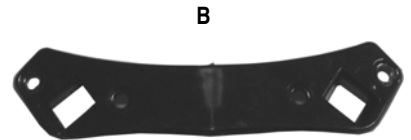
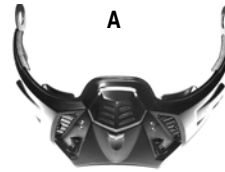

CHINBAR

Description
(A) Replacement Chinbar
(B) Chinbar Lock Plate

p/n
4272-998
4282-223



VISOR

Description
Visor - Black (2007-2009)

p/n
4272-999



CHIN PAD

Description
Chin Pad

p/n
4262-933



VRE MUSIC ADAPTER CORD

Description
Adapter Cord
Cat Comm MP3/Satellite Radio Cord - 80"

p/n
4262-906
4292-950

High Altitude Kits

2012 Models	Altitude	p/n	Components
F 570 T 570 Bearcat 570	5-9,000 ft.	5639-489	(2) 6505-029 Pilot Jet 35 (3) 0746-695 (67.0 g) Cam Arm (1) 0748-700 (P1 36°)(N) Torque Bracket
	Over 9,000 ft.	5639-490	(2) 6505-029 Pilot Jet 35 (3) 0746-670 (65.0 g) Cam Arm (1) 0748-700 (P1 36°)(N) Torque Bracket
Bearcat 570 XT	5-9,000 ft.	5639-627	(2) 6505-029 Pilot Jet 35 (3) 0746-669 (60.0 g) Cam Arm (1) 0748-700 (P1 36°)(N) Torque Bracket
	Over 9,000 ft.	5639-490	(2) 6505-029 Pilot Jet 35 (3) 0746-670 (65.0 g) Cam Arm (1) 0748-700 (P1 36°)(N) Torque Bracket
Bearcat Z1 XT	5-9,000 ft.	5639-935	(3) 0746-828 (57.0 g) Cam Arm
	Over 9,000 ft.	5639-936	(3) 0746-829 (52.0 g) Cam Arm (1) 0646-433 Gold Stripe Clutch Spring
Bearcat Z1 XT GS	Over 9,000 ft.	5639-937	(3) 0746-828 (57.0 g) Cam Arm (1) 0646-433 Gold Stripe Clutch Spring
TZ1 (Non Turbo)	5-9,000 ft.	4639-687	(3) 0746-678 (P3 55.0 g) Cam Arm (1) 0748-662 (36°) Torque Bracket
	Over 9,000 ft.	4639-639	(3) 0746-663 (52.0 g) Cam Arm (1) 0748-662 (36°) Torque Bracket
F5 LXR	5-9,000 ft.	4639-639	(3) 0746-663 (52.0 g) Cam Arm (1) 0748-662 (36°) Torque Bracket
	Over 9,000 ft.	4639-640	(3) 0746-792 (47.0 g) Cam Arm (1) 0748-662 (36°) Torque Bracket
F 800	5-9,000 ft.	5639-972	(3) 0746-671(P1 70.0 g) Cam Arm
	Over 9,000 ft.	5639-974	(3) 0746-695 (P1 67.0 g) Cam Arm - Wide (1) 0748-729 (36°) Torque Bracket*
F 1100 (Non Turbo)	5-9000 ft.	5639-978	(3) 0746-663 (52.0 g) Cam Arm
	Over 9,000 ft.	5639-979	(3) 0746-705 (P2 49.0 g) Cam Arm -
Sno Pro 500	5-9000 ft.	5639-507	(3) 0746-666 (55.0 g) Cam Arm
	Over 9,000 ft.	5639-508	(3) 0746-661 (52.0 g) Cam Arm
XF 800 LXR, SP Models	3-6,000 ft.	5639-971	(3) 0746-716 (P1 73.0 g) Cam Arm - Wide (1) 0748-729 (36°) Torque Bracket*
	6-9,000 ft.	5639-973	(3) 0746-671 (P1 70.0 g) Cam Arm (1) 0748-729 (36°) Torque Bracket*
	Over 9,000 ft.	5639-974	(3) 0746-695 (P1 67.0 g) Cam Arm - Wide (1) 0748-729 (36°) Torque Bracket*
XF 800 High Country	0-3,000 ft.	5639-975	(3) 0746-672 (P1 75.0 g) Cam Arm (1) 0748-731 (42°/40°) Torque Bracket*
	3-6,000 ft.	5639-971	(3) 0746-716 (P1 73.0 g) Cam Arm - Wide (1) 0748-729 (36°) Torque Bracket*
	Over 9,000 ft.	5639-974	(3) 0746-695 (P1 67.0 g) Cam Arm - Wide (1) 0748-729 (36°) Torque Bracket*
XF 1100 (Non Turbo)	3-6,000 ft.	5639-977	(3) 0746-674 (P2 55.0 g) Cam Arm - Wide
	6-9,000 ft.	5639-978	(3) 0746-663 (P2 52.0 g) Cam Arm - Wide
	Over 9,000 ft.	5639-979	(3) 0746-705 (P2 49.0 g) Cam Arm - Wide
XF 1100 (Turbo)	6-9,000 ft.	0748-747	(1) 0748-731 (42°/40°) Torque Bracket*
	Over 9000 ft.	0748-747	(1) 0748-731 (42°/40°) Torque Bracket*
■NOTE: M 800 and M 1100 models have been set up at the factory to operate at an altitude of 6,000 to 9,000 feet.			
M 800	0-3,000 ft.	5639-975	(3) 0746-672 (P1 75.0 g) Cam Arm (1) 0748-731 (42°/40°) Torque Bracket*
	3,000-6,000 ft.	5639-227	(3) 0746-716 (P1 73.0 g) Cam Arm - Wide
	Over 9,000 ft.	4639-644	(3) 0746-695 (P1 67.0 g) Cam Arm - Wide
M 1100 (Non Turbo)	0-3,000 ft.	5639-976	(3) 0746-632 (60.0 g) Cam Arm - Wide
	3,000-6,000 ft.	5639-977	(3) 0746-674 (P2 55.0 g) Cam Arm - Wide
	Over 9,000 ft.	5639-979	(3) 0746-705 (P2 49.0 g) Cam Arm - Wide

* w/bearing assembly

■NOTE: For more information on the High Altitude Kit Exchange Program, see page 1.

2012 Optional Rear Suspension Springs

Model	Standard Rear Arm Spring	Optional Rear Arm Spring	Spring Type
Bearcat 570, T570, TZ1 Models	1704-146/147	L 1704-678/679 H 1704-360/361	SQUARE SQUARE
F 800 Models, F 1100 Models	1704-576/577	L 1704-354/355 H 1704-560/561	SQUARE SQUARE
F5, F570	1704-504/505	L 1704-576/577 H 1704-710/711	SQUARE SQUARE
BC XT GS	1704-842/843	L N/A H 1704-384/385	SQUARE SQUARE
BC 570 XT/BC Z1 XT	1704-852/853	L 1704-562/563 H 1704-842/843	SQUARE SQUARE

Rear Suspension Spring Selection Chart

This chart was compiled to assist technicians in fine-tuning the Arctic Cat rear suspension when the original springs are not satisfactory and a softer or firmer ride is desired. A longer spring in areas (D) and (E) can be selected if cut off to match the original spring. The replacement spring must match the original spring in areas (D) and (E).

■NOTE: The wire diameter and length of the spring have a large influence over the valving of the shocks.

■NOTE: When installing Springs (p/n 1704-148/149), you must also use the white Plastic Sleeves (p/n 2604-379).

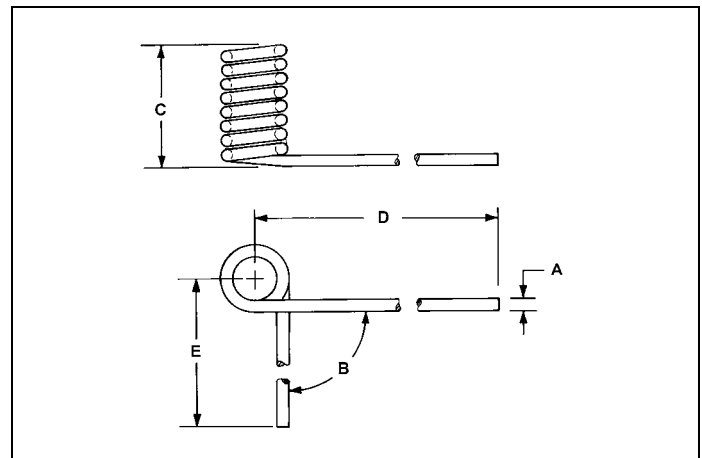

P/N	Replaced By	Wire Diameter (A)	Angle (B)	Number of Coils	Coil Width (C)	Length (D)	Length (E)	Spring Type
0604-054/053		.406	65°	7.75	3.88	17.50	4.50	Round
0604-118/117	1704-174/175	.460	45°	9.00	4.75	17.50	4.50	Round
0604-272/273		.437	90°	9.00	4.80	17.50	5.50	Round
0604-282/283		.437	75°	9.00	4.80	17.50	5.50	Round
0604-288/289		.460	60°	9.00	4.75	17.50	4.50	Round
0604-290/291		.490	60°	9.00	5.02	17.50	4.50	Round
0604-314/315**		.460	90°	9.00	5.03	17.50	5.50	Round
0604-400/401	1704-182/183	.406	90°	8.75	4.32	17.50	5.50	Round
0604-454/455*		.437	90°	9.00	4.80	17.50	4.50	Round
0604-474/475	1704-072/073	.406	90°	7.75	3.88	17.50	4.50	Round
0604-492/493		.406	90°	8.75	4.32	15.75	5.50	Round
0604-584/585	0704-986/987	.406	90°	8.75	4.32	18.10	5.70	Round
0604-592/593		.460	83°	8.75	4.80	15.75	5.50	Round
0604-654/655		.437	83°	8.75	4.59	20.00	5.70	Round
0604-660/661		.437	83°	8.73	4.59	18.10	5.70	Round
0604-746/747		.390	90°	8.75	4.32	19.75	5.70	Round
0604-970/971*		.421	90°	8.75	4.43	15.90	5.70	Round
0704-822/821		.452	90°	8.75	4.45	18.75	5.50	Round
0704-856/857**		.437	90°	8.75	4.59	20.00	5.70	Round
0704-876/877	1604-616/617	.375	90°	5.75	3.00	15.62	5.12	Square
0704-886/887**	1604-060/601	.460	77°	8.75	4.85	20.00	5.50	Round
0704-888/889**	1604-062/063	.437	75°	8.75	4.60	18.00	5.50	Round
0704-890/891	1604-600/601	.359	90°	5.75	3.00	15.62	5.12	Square
0704-892/893	1604-818/819	.405	75°	8.75	4.32	19.00	5.50	Square
0704-902/901		.405	80°	7.75	3.92	19.00	5.50	Square
0704-908/909**		.437	75°	8.75	4.60	18.50	5.50	Round
0704-926/927	2604-352/353	.375	80°	5.75	3.00	18.50	5.12	Square
0704-934/935	2604-356/357	.405	90°	5.75	3.00	18.50	5.12	Square
0704-938/939	1604-442/443	.452	90°	8.75	4.53	16.00	5.70	Round
0704-944/945**	1604-604/605	.452	75°	8.75	4.62	18.75	5.50	Round
0704-968/969		.437	90°	6.75	3.50	18.50	5.12	Square
0704-988/989**		.437	90°	8.75	4.59	18.10	5.70	Round
0704-990/991	1604-178/179**	.421	77°	8.75	4.32	20.00	5.50	Round
0704-994/995	1604-388/389**	.452	75°	8.75	4.60	18.00	5.50	Round
1604-065/064		.421	75°	8.75	4.45	18.00	5.50	Round
1604-067/066	1704-083/082	.460	75°	8.75	4.83	18.00	5.50	Round
1604-076/077**		.460	97°	9.00	4.53	16.00	5.70	Round
1604-078/079**	1704-300/301	.437	83°	8.75	4.56	21.00	5.70	Round
1604-144/145***	1704-302/303	.437	77°	8.75	4.52	22.00	8.00	Round
1604-146/147***		.421	77°	8.75	4.52	22.00	8.00	Round
1604-149/148**	1704-289/288	.460	77°	8.75	4.84	22.00	8.00	Round
1604-194/195**	1704-088/089	.460	90°	8.75	4.53	16.00	6.70	Round
1604-224/225**	1704-290/291	.460	83°	8.75	4.53	21.00	5.70	Round
1604-381/380***	1704-135/134	.452	77°	8.75	4.97	22.00	8.00	Round
1604-608/609	1704-344/345	.437	83°	8.75	4.59	20.75	5.70	Round
1604-739/740**		.437	75°	8.75	4.60	16.00	5.50	Round
1704-044/045		.405	75°	8.75	4.32	18.50	5.50	Square
1704-146/147		.405	70°	6.75	4.32	18.50	5.50	Square
1704-148/149		.437	75°	7.75	4.25	18.50	5.50	Square
1704-184/185		.421	90°	8.75	4.43	18.10	5.70	Round
1704-260/261		.405	70°	7.75	3.85	18.50	5.50	Square
1704-352/353		.375	80°	7.75	3.80	18.50	5.50	Square
1704-354/355		.375	75°	8.75	4.32	18.50	5.50	Square
1704-360/361		.405	70°	5.75	4.00	18.50	5.50	Square
1704-382/383		.359	90°	5.75	3.00	15.62	4.60	Square
1704-384/385		.375	90°	5.75	3.00	15.62	4.60	Square
1704-444/445		.437	90°	6.75	3.65	18.50	5.50	Square
1704-504/505		.405	85°	6.75	3.65	18.50	5.50	Square
1704-560/561		.405	85°	6.75	3.65	18.50	5.48	Square
1704-562/563		.405	70°	6.75	4.50	18.50	5.50	Square
1704-566/567		.405	85°	6.75	3.65	18.50	5.36	Square
1704-576/577		.405	94°	6.75	3.65	18.50	5.50	Square
1704-678-679		.405	78°	6.75	4.00	18.50	5.50	Square
1704-710/711		.405	75°	6.75	3.65	18.50	5.50	Square
1704-808/809		.405	90°	8.00	3.87	18.50	5.50	Square
1704-842/843		.437	80°	7.75	4.50	18.50	5.50	Square
1704-852/853		.437	75°	7.75	4.50	18.50	5.50	Square
2604-044/045		.452	90°	8.75	4.68	18.75	5.50	Round
2604-566/567*		.488	85°	5.75	4.00	18.75	5.50	Round
2604-612/613		.405	70°	6.75	4.00	18.50	5.50	Square
2604-898/899*		.465	80°	5.00	3.40	18.75	5.50	Round
2704-224/225		.437	105°	8.80	3.75	15.62	4.70	Square
3604-488/489		.437	80°	7.75	4.50	18.50	5.50	Square

*Long leg of spring is bent inward **Short leg of spring is bent inward ***Must be cut to correct length • Titanium ** Spring color is Platinum

Drive Belts

Application Guide

1988	1996 (Cont.)	2001 (Cont.)	2007 (Cont.)
Jag 340, 440, Jag Deluxe.....0227-100	Z440, Panther Deluxe, Panther L/C.....0627-012	Mountain Cat Models.....0627-020	Panther 370/570.....0627-021
Super Jag, Panther.....0227-030	Bearcat 340.....0627-013	Pantera Models.....0627-020	Panther 660.....0627-013
Cougar, Pantera.....0227-101	Bearcat 440 & 550.....0627-014	Panther 370 Models.....0627-013	T660.....0627-048
El Tigre 5000, 6000.....0227-101	Cougar, Cougar 2-Up, Cougar M/C.....0627-012	Panther 440 Models.....0627-012	Z 370/570.....0627-021
Cheetah Touring, L/C.....0227-101	Pantera.....0627-012	Panther 550.....0627-021	
Wildcat 650.....0627-004	EXT EFI Models.....0627-012	Thundercat.....0627-020	
1989	EXT 580.....0627-012	Triple Touring 600.....0627-020	
Jag 340, Jag Deluxe.....0227-100	EXT 580 Powder Special.....0627-010	Z Models.....0627-021	
Super Jag, Jag AFS.....0227-032	Wildcat Models.....0627-010	ZL Models.....0627-020	
Panther, Cougar.....0227-032	Thundercat, ZRT 800, ZRT 600.....0627-010	ZR Models.....0627-020	
Pantera, Cheetah Touring.....0227-032	ZR 580 Models, ZR440.....0627-012		
El Tigre 6000, EXT.....0227-032		2002	
Wildcat 650.....0627-001		Bearcat W/T.....0627-014	
1990	1997	Mountain Cat Models.....0627-020	
Jag 340.....0227-100	Puma, Puma Deluxe, Puma 2-Up.....0627-012	Pantera 550.....0627-021	
Jag Mountain Cat.....0227-100	Jag, Jag Deluxe.....0627-012	Pantera Models (EFI).....0627-020	
Panther, Jag AFS.....0227-103	Jag, Jag Deluxe.....0627-012	Panther Models.....0627-021	
Cougar, Cheetah Touring.....0227-103	Panther, Panther L/C.....0627-012	Thundercat.....0627-020	
Pantera, El Tigre EXT.....0227-103	Z440, ZL440.....0627-012	Z Models.....0627-021	
Wildcat 650.....0627-006	Bearcat 340.....0627-013	ZL Models.....0627-020	
Prowler.....0227-103	Bearcat 440 & 550.....0627-014	ZR Models.....0627-020	
	Cougar, Cougar M/C.....0627-012	ZRT 600.....0627-020	
1991	Pantera.....0627-012		
Lynx.....0227-030	EXT EFI Models.....0627-012	2003	
Jag AFS, Panther.....0227-103	Powder Special EFI.....0627-012	Bearcat W/T.....0627-026	
Jag Long Track.....0227-103	Thundercat, ZRT 800, ZRT 600.....0627-010	Firecat 500/600 Models.....0627-020	
Super Jag.....0227-103	ZR 580, ZR440.....0627-010	Firecat 700 Models.....0627-020/035*	
Jag 340 Mountain Cat.....0227-100	EXT 600, Powder Extreme.....0627-010	4-Stroke Touring/Trail.....0627-013	
Cougar, Cheetah Touring.....0227-103	Powder 580 Carb.....0627-010	Mountain Cat Models.....0627-020	
Pantera, Prowler.....0227-103		Pantera 550.....0627-021	
El Tigre EXT.....0227-103	1998	Pantera Models (EFI).....0627-020	
Prowler Special.....0227-103	Jag 340, Panther 340.....0627-012	Panther Models.....0627-021	
EXT Special.....0227-103	Jag 440, Jag 440 DLX.....0627-012	Z Models.....0627-021	
Wildcat 700.....0627-006	Z 440, Panther 440.....0627-012	ZL Models.....0627-020	
	Panther 550.....0627-021	ZR Models.....0627-020/035*	
1992	Bearcat 340.....0627-013		
Jag, Jag Special.....0227-103	Bearcat 440, Bearcat Wide Track.....0627-014	2004	
Super Jag.....0227-103	Cougar, Cougar DLX, Cougar M/C.....0627-021	Bearcat 570.....0627-013	
Jag AFS L/T.....0227-103	Pantera 580.....0627-021	Bearcat W/T.....0627-033	
Cheetah.....0227-103	Pantera 800.....0627-020	Firecat 500 Models.....0627-020	
Cougar.....0227-103	EXT EFI.....0627-020	Firecat 600/700 Models.....0627-031	
Lynx, Lynx Deluxe.....0227-030	EXT EFI DLX.....0627-021	King Cat.....0627-020	
Lynx Mountain Cat.....0227-103	EXT 600, EXT 600 Touring.....0627-020	Mountain Cat Models.....0627-020	
Pantera.....0227-103	Powder Special, Powder Special EFI.....0627-020	Pantera 550.....0627-021	
Prowler, Prowler Special.....0227-103	Powder Extreme.....0627-020	Pantera Models (EFI).....0627-020	
EXT, EXT Special.....0227-103	Thundercat, Thundercat M/C.....0627-020	Panther Models.....0627-021	
Panther.....0227-103	ZRT 600, ZRT 800.....0627-020	Sabercat 500.....0627-020	
Wildcat (AWS).....0627-008	ZR 600, ZR 600 EFI.....0627-020	Sabercat 600/700 Models.....0627-031	
Wildcat EFI (AFS).....0627-006	ZL 440.....0627-021	T660 Touring.....0627-021	
	ZL 500, ZR 500.....0627-020	T660 Turbo Models.....0627-028	
1993	ZR 440.....0627-020	Z Models.....0627-021	
Jag, Jag 440 Z.....0227-103	1999	ZR Models.....0627-032	
Jag AFS L/T.....0227-103	Jag 340 DLX, Panther 340.....0627-012		
Cheetah.....0227-103	Jag 440, Jag 440 DLX.....0627-012	2005	
Cougar.....0227-103	Panther 440.....0627-012	Bearcat 570.....0627-013	
Lynx, Lynx Deluxe.....0227-030	Panther 550.....0627-021	Bearcat W/T.....0627-033	
Lynx Mountain Cat.....0227-103	Sabercat 340, Bearcat 440 I.....0627-013	Firecat 500 Models.....0627-034	
Pantera.....0227-103	Bearcat 440 II, Bearcat Wide Track.....0627-014	Firecat 600/700 Models.....0627-034	
Prowler, Prowler 440Z.....0227-103	Pantera 580 EFI.....0627-021	King Cat.....0627-020	
EXT, EXT 580 Z.....0227-103	Pantera 800.....0627-020	M-Series.....0627-036	
Panther.....0227-103	Triple Touring 600.....0627-020	Pantera 550.....0627-021	
Wildcat.....0627-011	Powder Special 500 EFI.....0627-020	Panther Models.....0627-021	
ZR Models.....0627-012	Powder Special 600 Models.....0627-020	Sabercat 500.....0627-020	
Thundercat.....0627-010	Powder Special 700.....0627-020	Sabercat 600/700 Models.....0627-035	
	Thundercat, Thundercat M/C.....0627-020	T660 Touring.....0627-021	
1994	Z 370.....0627-021	T660 Turbo Models.....0627-028	
Puma, Puma Deluxe, Puma 2-Up.....0227-103	Z 440.....0627-021	Z Models.....0627-021	
Jag, Jag 440Z.....0227-103	ZL 440.....0627-021	ZR 900 Models.....0627-032	
Cheetah Models.....0227-103	ZL 500 Models.....0627-020		
Cougar.....0227-103	ZL 600 Models.....0627-020	2006	
Pantera.....0227-103	ZR 500 Models.....0627-020	Bearcat 570.....0627-013	
Prowler EFI.....0227-103	ZR 600 Models.....0627-020	Bearcat W/T.....0627-033	
EXT 580 Models.....0627-012	ZRT 700.....0627-020	Bearcat W/T Turbo.....0627-049	
Panther Deluxe.....0227-103	ZRT 600, ZRT 800.....0627-020	Crossfire Models.....0627-036	
Wildcat EFI.....0627-011		Firecat 500 Models.....0627-044	
ZR Models.....0627-012	2000	Firecat 600 EFI r.....0627-020	
Thundercat.....0627-010	Bearcat 340.....0627-013	Firecat 600/700 Models (w/o Reverse) 0627-044	
	Bearcat 440 I/440 II/ Wide Track.....0627-014	Firecat 700 EFI r.....0627-035	
1995	Pantera Models.....0627-020	King Cat Models.....0627-020	
Puma, Puma Deluxe, Puma 2-Up.....0227-103	Panther 340/440.....0627-012	M-Series Models.....0627-036	
Jag, Jag Deluxe.....0227-103	Panther 550.....0627-021	Panther 370/570 Models.....0627-021	
Panther.....0227-103	Powder Special Models.....0627-020	Panther 660 Models.....0627-013	
Bearcat 340.....0627-013	Thundercat Models.....0627-020	Sabercat 500/600 Models.....0627-020	
Bearcat 440 & 550 0627-014	Triple Touring 600.....0627-020	Sabercat 700 Models.....0627-035	
Cougar.....0627-012	Z Models.....0627-021	T660 Touring.....0627-035	
Prowler.....0627-012	ZL 440/550.....0627-021	T660 Turbo Models.....0627-048	
Pantera.....0627-012	ZL 500/580/600/700.....0627-020	Z Models.....0627-021	
EXT.....0627-012	ZRT Models.....0627-020	ZR 900 EFI Models.....0627-045	
EXT Powder Special.....0627-010			
Wildcat, Wildcat Touring.....0627-010	2001	2007	
Thundercat.....0627-010	Bearcat W/T.....0627-014	Bearcat 570.....0627-013	
Z440.....0627-012		Bearcat W/T.....0627-033	
ZR440, ZR580.....0627-012		Bearcat W/T Turbo.....0627-049	
ZR700.....0627-010		Crossfire 5/6/8.....0627-046	
ZRT800.....0627-010		Crossfire 1000.....0627-060	
		F-Series 5/6/8.....0627-046	
1996		F1000.....0627-060	
Puma, Puma Deluxe, Puma 2-Up.....0227-103		Jaguar Z1.....0627-047	
Jag, Jag Deluxe, Jag L/C.....0227-103		M-Series.....0627-046	

Dimension Chart

BELT P/N	LENGTH	WIDTH
0100-088	43.125 ± .188 inch	1.188 inch
0100-092	43.813 ± .188 inch	1.250 inch
0227-011	44.000 ± .188 inch	1.250 inch
0227-014	45.500 ± .188 inch	1.250 inch
0227-016	45.063 ± .188 inch	1.250 inch
0227-019	43.250 ± .188 inch	1.250 inch
0227-020	46.688 ± .188 inch	1.250 inch
0227-030	43.500 ± .188 inch	1.375 inch
0227-100	45.500 ± .188 inch	1.375 inch
0227-103	43.625 ± .125 inch	1.375 inch
*0627-002	43.625 ± .188 inch	1.375 inch
*0627-004	43.625 ± .188 inch	1.375 inch
*0627-006	43.625 ± .188 inch	1.375 inch
*0627-010	47.750 ± .188 inch	1.375 inch
*0627-011	45.750 ± .188 inch	1.375 inch
*0627-012	47.750 ± .188 inch	1.375 inch
0627-013	49.000 ± .188 inch	1.437 inch
0627-014	49.000 ± .188 inch	1.437 inch
*0627-020	48.071 ± .188 inch	1.406 inch
*0627-021	47.750 ± .188 inch	1.385 inch
*0627-031	47.750 ± .178 inch	1.382 inch
*0627-032	44.570 ± .178 inch	1.448 inch

BELT P/N	LENGTH	WIDTH
*0627-033	50.285 ± .188 inch	1.437 inch
*0627-034	44.024 ± .178 inch	1.448 inch
*0627-035	47.750 ± .178 inch	1.400 inch
*0627-036	45.024 ± .178 inch	1.448 inch
*0627-044	44.706 ± .178 inch	1.448 inch
*0627-045	45.223 ± .178 inch	1.448 inch
*0627-046	45.998 ± .178 inch	1.448 inch
*0627-047	43.547 ± .178 inch	1.448 inch
*0627-048	46.986 ± .178 inch	1.448 inch
*0627-049	48.162 ± .178 inch	1.448 inch
*0627-059	48.162 ± .178 inch	1.448 inch
**0627-060	45.998 ± .178 inch	1.448 inch
*0627-067	45.394 ± .178 inch	1.406 inch
*0627-069	42.953 ± .178 inch	1.406 inch
*0627-070	44.250 ± .178 inch	1.448 inch
***0627-073	43.547 ± .178 inch	1.448 inch
**0627-075	44.250 ± .178 inch	1.448 inch
**0627-076	43.547 ± .178 inch	1.448 inch
*0627-081	46.378 ± .178 inch	1.448 inch
***0627-082	46.259 ± .178 inch	1.448 inch
**0627-083	47.519 ± .178 inch	1.448 inch
***0627-084	47.519 ± .178 inch	1.448 inch
***0627-085	48.149 ± .178 inch	1.448 inch

*High Performance **Improved Compression Resistance; Improved Heat Resistance ***Best Compression Resistance; Best Heat Resistance

■NOTE: The difference between a * drive belt and a ** drive belt of the same dimension is hardness. A ** drive belt is more flexible and if used in place of a * drive belt, the engine will run at a lower RPM.

Index

■NOTE: Bolded Items are not found in the CAtalog.

#	
120	44

A	
A-ARM KIT, 38"	38
ACCESSORY ADAPTER	62
AIRBOX KIT, SPLIT	63
ALTITUDE KITS, HIGH	72
ANTIFREEZE	56
AVALANCHE AIRBAG	34
AVALANCHE BEACONS	34
AVALANCHE PROBE	35
AXLE KIT, LIGHTWEIGHT FRONT	37

B	
BAGS	
Backpack	35
Dimensions	11
Foam Beverage Holder	18
Gear	16,39,32
Handlebar	17,32
Heater	17
Mountain Pack	32
Saddlebags	16
Seat Pack	18
Tank	18
Trunk, Firecat	18
Tunnel Pack	16,39,32
Underhood	18
Windshield	16,18,33
Replacement Hardware	18
BATTERY CHARGERS/MAINTAINERS	61
BELTS, DRIVE	63
Application Guide	74
Dimension Chart	75
Holder	62
BILLET ACCESSORIES	26-26, 33
BODY PANELS, VENTED	35-36
BUMPER	19,40

C	
CAM ROLLER, HI-TEMP	37
CARGO SLEDS	41-42
CHOKE LEVER REPAIR KIT	66
CLEANERS	57,58
CLUTCH FAN KIT	63
COVERS	
Arctic Cat Canvas Covers	14
Custom	14
Dust	15
Headlight	31
Premium	14
Team Arctic	14
Undercover Liner	15
Replacement Straps	15

D	
DC POWER KIT	21
DRIVE CLUTCH SPRING	66
DOLLY	
Cat Caddy	59
Shop	60

E	
ELECTRIC START KIT	21
ENGINE HEATER	21

F	
FLUID	
ACT Gearcase	55
Fox Float	57
Flush	55
FUEL	
High Octane Race	57
De-Icer	56
Injection & Carburetor Cleaner	56
Stabilizer	56
FUEL PUMP REPAIR KITS	65

G	
GASKET SETS	65
GAUGE, TEMPERATURE	62
GOGGLE HOLDER	33
GREASE	57
GRAPHIC KITS	25
GRIP PLATES	29

H	
HANDLEBAR	
Grip Adhesive	65
Grips	27
Heavy-Duty	64
Muffs	17
Risers	36, 62
Stand	59
Steering Post Stand	59
HAND GUARD MOUNTS	27
HAND GUARDS	27
HAND WARMER KIT	44
HAND WARMERS, PASSENGER	42
HEATED SEAT KIT	21
HEATED SHIELD ADAPTER	60
HELMET PARTS	67-71
HITCH KITS	20,21,40
HOOD LATCH REPAIR KIT	63
HORN KIT	63

I	
ICE SCRATCHERS	35

L	
LIFT	
Sled	59
Front End	59
LIGHT	
Backup	42
Bar	40
Strobe	40
LOCTITE	65
LUBE	
Transmission	55
Chain	55

M	
MIRRORS	31
Hood-Mounted	31

O	
OIL	
Engine	54
Shock	55-56
OVERLOAD SPRING TOOL	66

P	
PAINT	61
PINK ACCESSORY KITS	25

R	
RACK	
Billet	33
Cargo	39
Sport	20
Crossfire	20
Procross	20
Proclimb	33
Touring	20
Mat/Pad	42,37
M Series	33
Strap	34
RADIATOR KIT	43
RAIL BRACE KIT	64
A. RECOIL HANDLE	26,26
REMOTE START KIT	22
HANDLEBAR GRIPS	27

S	
SAW, POCKET	35
SEALANT	65-65
SEAT COVER, GRIPPER	29
SEAT KIT, 2-UP	19
SEAT KIT, PASSENGER	43
SEAT, MOUNTAIN	34
SEAT, THIRD	39
SHOCKS	
FOX Float	25-26
Airshox Guards	26
Airshox Pump	26
Rebuild Kits	66
SHOVELS	35
SIDE RAILS	39
SKI	
Handles	28
Plastic	28-28
Skins	42
SKID PLATES	29
SNOBUNJE	37
SNOWFLAPS	30,31,53
SNOW MESH	30,39
SNOW PLOW	
Blades	41
Push Frame	41
SPARK PLUGS	64
Caddy	62
Caps	64
SPRING CHART, OPTIONAL	72-73
SPRING KIT, OVERLOAD	43
STAND, JACK	59
STEERING POST, TELESCOPIC	36
STUD ACCESSORIES	49-53
SWAY BAR KITS	42
SWITCH GUARDS	36

T	
TANK	
Grips	33
Jacket	33
Pads	32
TAPE	60
TETHER SWITCH	21
TIE-DOWNS	60
TOE HOLD	30
TOW ROPE	60
TRACKS	45,46
TRACK CLIP TOOL	66
TRAIL GROOMER	43
TUNNEL GRIPS	29
TUNNEL PROTECTOR KIT	53
TUNNEL RAILS	19

W	
WEARBARS	47-48
WEAR STRIPS	31
WHEELS, IDLER	29
WHEEL KITS	38,44,63
WINCH KIT, WARN	40,41
WINDSHIELDS/WINDSCREENS	23
WINDSHIELD MOUNTING RING	24
WINDSHIELD SIZE CHART	24

Snowmobile Safety and
3975 University Drive Suite 310



Certification Committee, Inc.
Fairfax, Virginia 22030 (703) 273-9606

ISMA
International
Snowmobile
Manufacturers
Association

Challenger™, Cobra™, HackSaw™, ICE Claw™, ICE Ripper™, and RipSaw™ are trademarks of Camoplast Inc. CTEK® is a trademark of CTEK Power, inc. EVOL™, FOX® and FOX FLOAT® AirShox are trademarks of FOX Racing Shox, Inc. Float 30™, Tracker DTS™, and Tracker2™ are trademarks of Backcountry Access, Inc. Mikuni® is a trademark of Mikuni Manufacturing. NGK® is a trademark of NGK Spark Plugs, Ltd. OGIO® is a trademark of Ogio International. Deuce™, Power Plate™, Power Plate Plus™, Power Point™, Power Point Plus™, Shaper™, StudBoy® and Super-Lite Plus™ are trademarks of Liberty Products, Inc. Powder Pro Skis™ is a trademark of Starting Line Products, Inc. Tekrider™ is a trademark of Tek Rider. Velcro® is a trademark of Scotchmate Inc. Warn® is a trademark of Warn Industries, Inc. Woody's®, Dooly™, Double Digger™, Gold Digger®, Grand Master™, Signature Series™, and Traction Master® are trademarks of International Engineering and Manufacturing, Inc. Yuasa® is a trademark of Yuasa Battery, Inc.

ACT™, Advantage®, Arctic Cat®, Arctic Power Valve™, Arcticwear®, A-Tex™, Bearcat®, Boss Cat™, Cat Comm™, Cat's Pride™, Cat's Pride Club™, Cat Tracker™, Cool Cat™, Cross Country™, Crossfire™, Firecat™, F Series™, Mountain Cat®, Panther®, Power Claw™, Pride™, Prowler®, Sabercat™, Share Our Passion™, Sno Cross®, Sno-Lock™, Sno Pro®, Speed Cat™, T660™, Team Arctic®, Tek™, Tom Cat™, World's Fastest Snowmobiles™, Z®, and ZR® are all trademarks of Arctic Cat Sales Inc., Thief River Falls, MN. ©2011 Arctic Cat Sales Inc.



Arctic Cat Sales Inc.
601 Brooks Avenue
Thief River Falls, MN 56701

All specifications, claims, and information contained within are based upon current knowledge as of February, 2012 and are subject to change without notice.

English - 5224-070